

Hold <b>6</b>	Skive <b>1</b>	<b>Bent Andersen</b>		
AAS		Vodskov Skytteforening		VÅ1
		Jyllandsstævne 2016	Aalborg Skyttekreds	
Prøve			1: 10.1	↗
			2: 9.4	↗
			3: 9.7	↗
			4: 10.4	↘
			5: 10.8x	↘
			6: 10.0	↗
			7: 10.9x	↗
		Serie	68.0	
		Total	0.0	
20 Skud			1: 9.7	↘
			2: 10.3	↘
			3: 9.3	↗
			4: 10.4	↗
			5: 10.4	→
			6: 9.9	↗
			7: 10.4	↖
			8: 10.8x	↗
			9: 10.2	↘
			10: 10.0	↗
		Serie	97.0	
		Total	97.0	
20 Skud			11: 10.5	↘
			12: 10.8x	↖
			13: 9.9	↖
			14: 10.1	↗
			15: 10.0	↗
			16: 10.4	↗
			17: 10.0	→
			18: 9.4	↗
			19: 10.2	↖
			20: 9.9	↗
		Serie	97.0	
		Total	194.0	

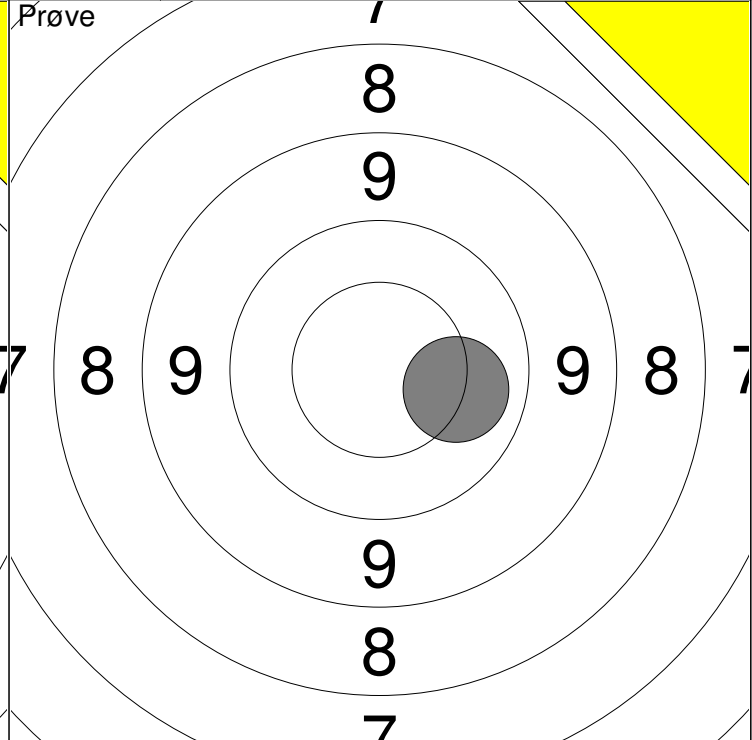

1: 9.7 ↖	6: 10.4 ↗	Serie	95
2: 9.9 ↖	7: 10.3 ↗		
3: 9.8 ↗	8: 10.5 ↘	Total	0
4: 9.6 ↗	9: 10.6 ↖		
5: 9.6 ←	10: 10.6x ↗		

11: 10.1 →	Serie	10
	Total	0

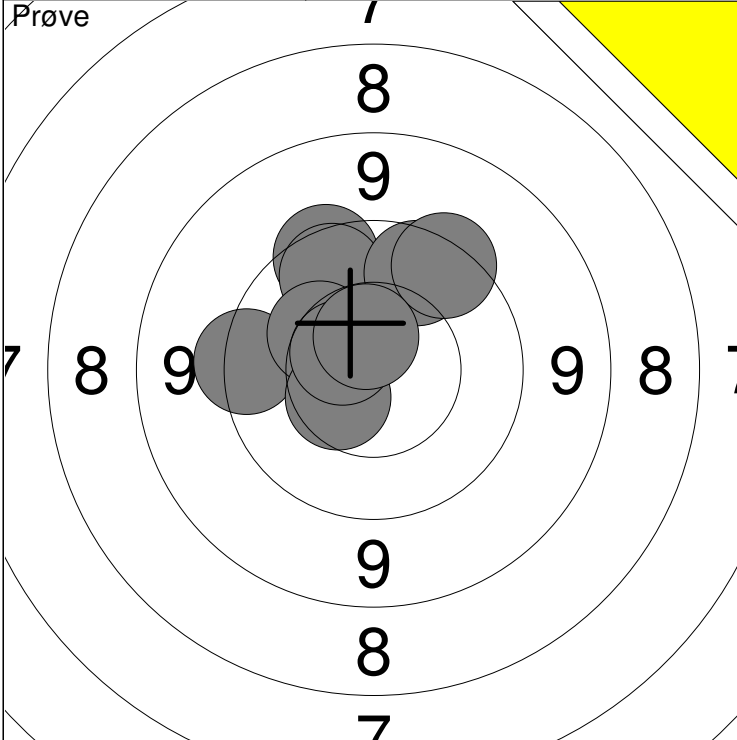
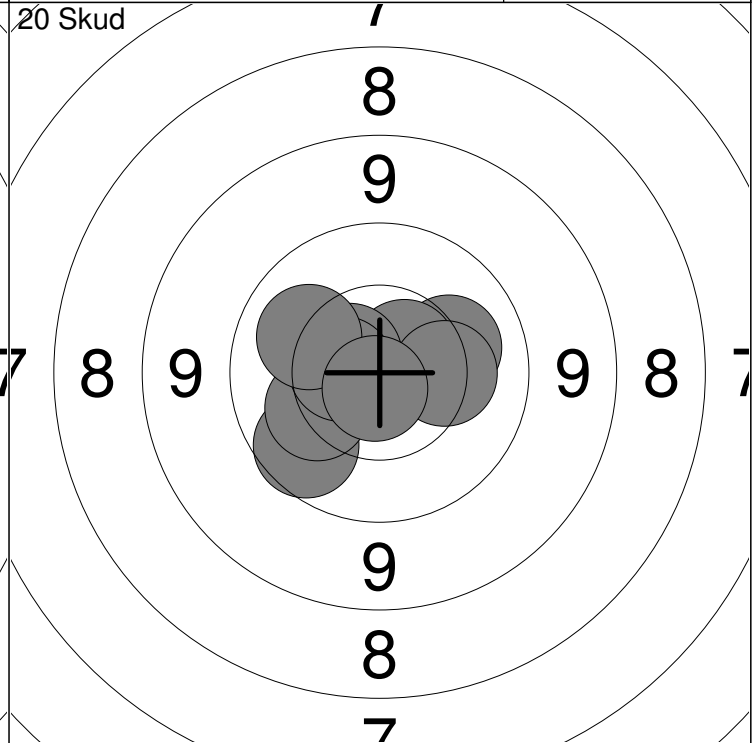
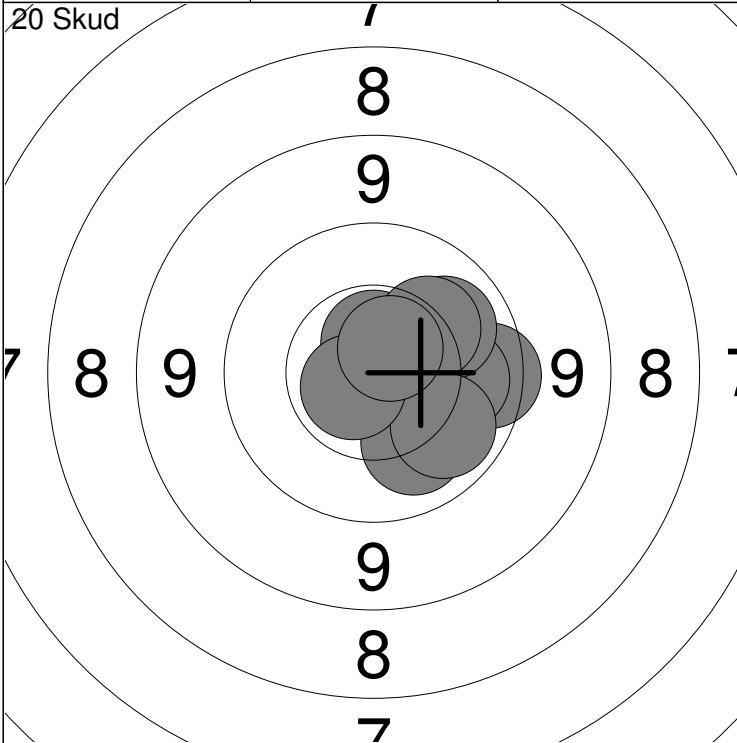

1: 10.6x ↑	6: 10.2 ↗	Serie	99
2: 9.7 →	7: 10.1 ↘		
3: 10.4 ↗	8: 10.1 ↘	Total	99
4: 10.1 →	9: 10.7x ↖		
5: 10.1 ↗	10: 10.6x ↗		

11: 10.2 →	16: 10.6x ↖	Serie	99
12: 9.9 ↖	17: 10.3 →		
13: 10.2 ↖	18: 10.6 ←	Total	198
14: 10.8x ↗	19: 10.1 ↖		
15: 10.6x ↗	20: 10.8x ↘		

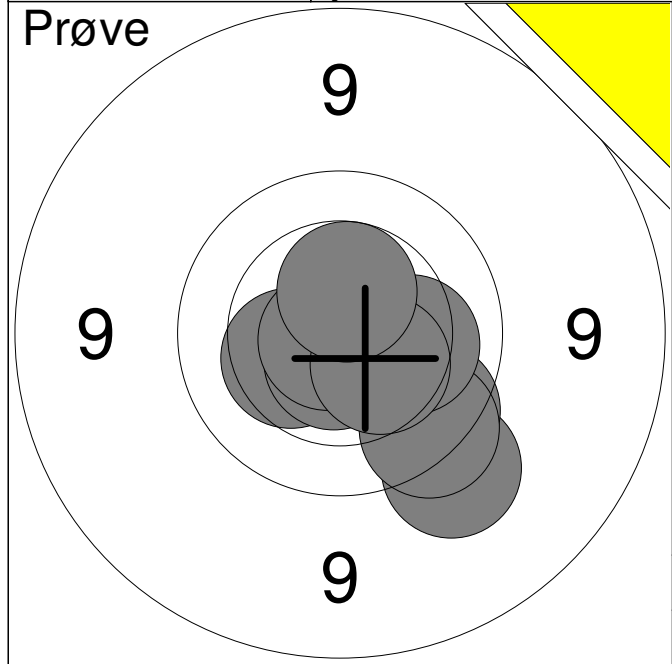

1:	9.4	↘
2:	9.8	↘
3:	10.4	↙
4:	9.7	↘
5:	10.7x	↘
6:	10.2	→
7:	10.8x	↙
8:	10.4	↘
9:	10.5x	↑
<b>Serie</b>		<b>87.0</b>
<b>Total</b>		<b>0.0</b>

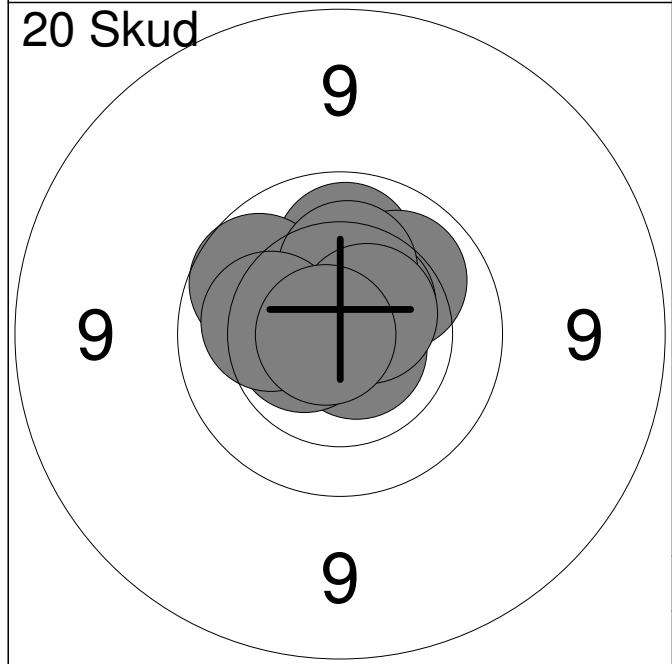

1:	10.1	↑
2:	10.1	↗
3:	9.9	↖
4:	10.5x	↗
5:	10.7x	↘
6:	10.6x	↙
7:	10.3	↑
8:	10.6x	↗
9:	10.2	↙
10:	10.8x	↙
<b>Serie</b>		<b>99.0</b>
<b>Total</b>		<b>99.0</b>

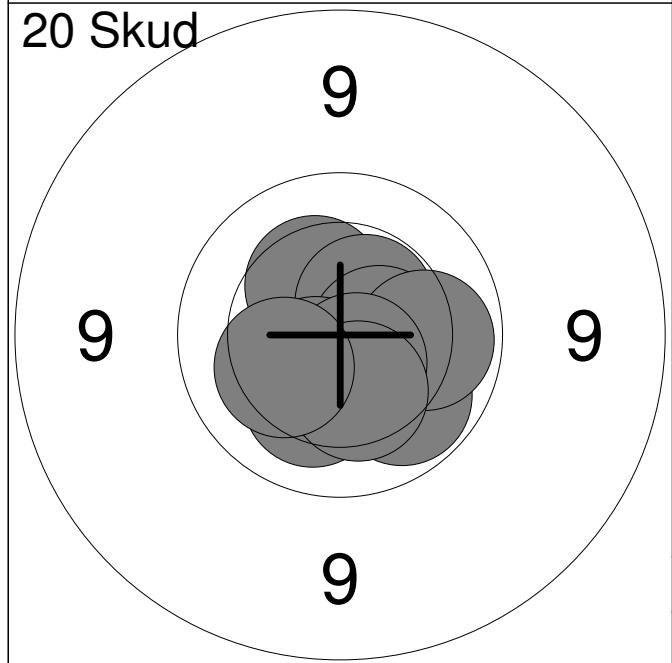

11:	10.2	↘
12:	10.0	↘
13:	10.4	↗
14:	10.5x	↗
15:	10.5x	→
16:	10.5x	↙
17:	10.0	→
18:	10.6x	↘
19:	10.3	↘
20:	10.3	↙
<b>Serie</b>		<b>100.0</b>
<b>Total</b>		<b>199.0</b>

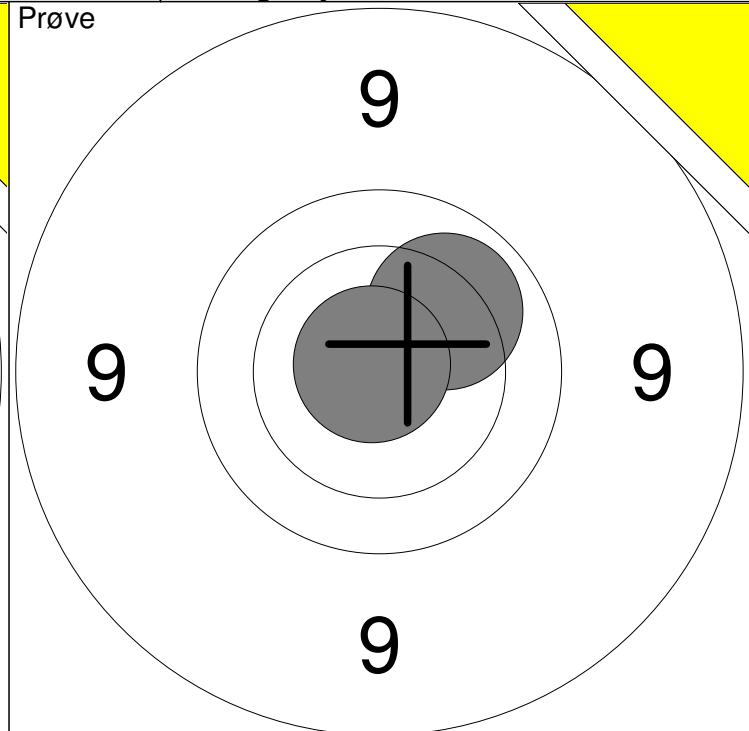
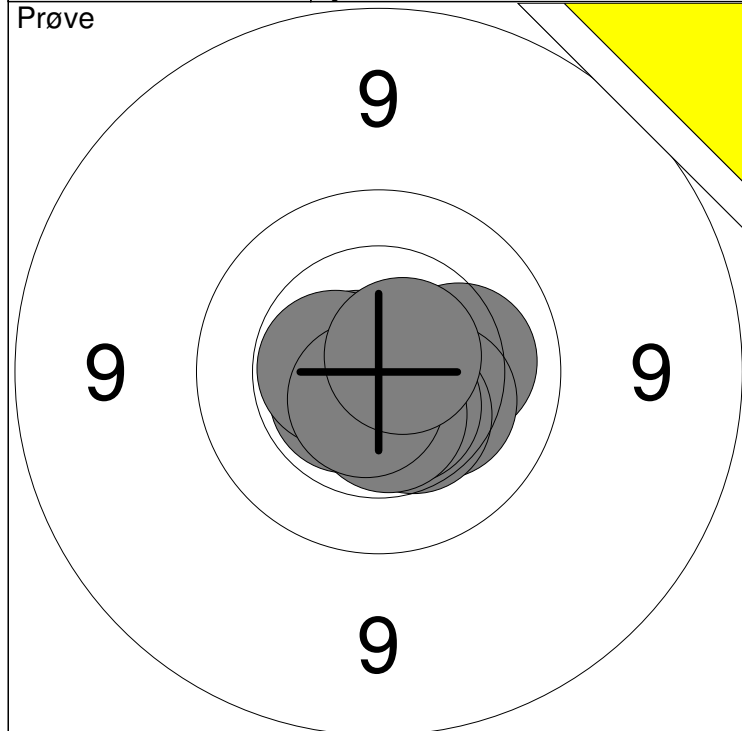

1: 10.2 →	6: 10.8x ←	Serie	100
2: 10.3 ↘	7: 10.5x ↓		
3: 10.6x ↙	8: 10.5x ←	Total	0
4: 10.4 ↘	9: 10.7x ↓		
5: 10.5x ↘	10: 10.7x ↗		

11: 10.1 ↗	Serie	20
12: 10.8x ↖		
Total		0

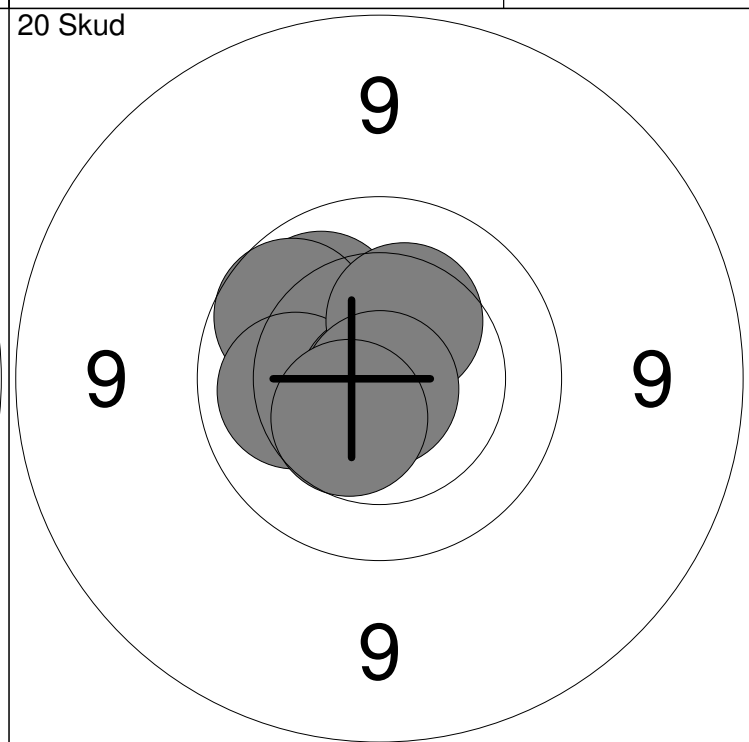
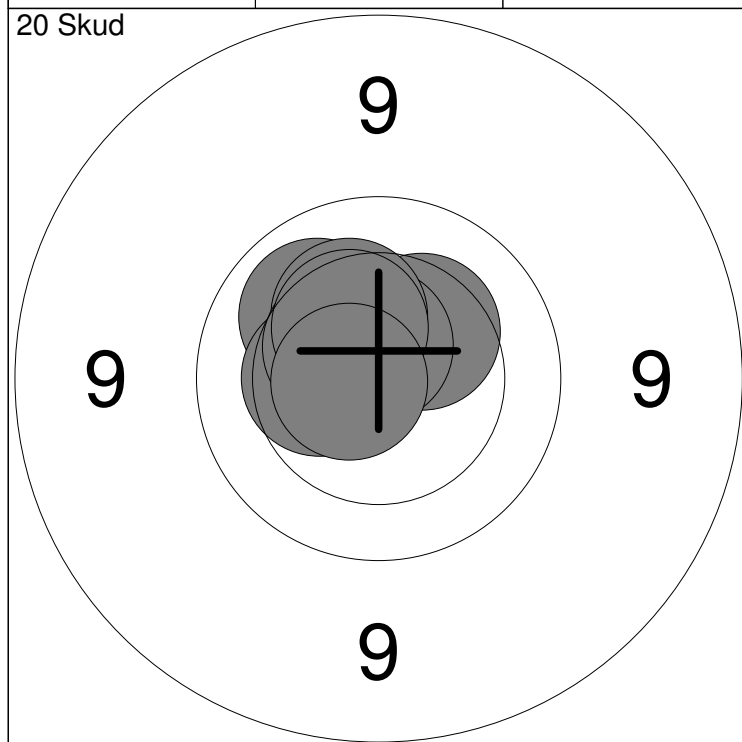

1: 10.1 ↗	6: 10.6x ↑	Serie	100
2: 10.5x ↑	7: 10.3 ↗		
3: 10.6x ↗	8: 10.5 ↗	Total	100
4: 10.4 ←	9: 10.4 ↗		
5: 10.3 ↗	10: 10.7x ←		

11: 10.1 ↗	16: 10.1 ←	Serie	99
12: 10.7x ←	17: 10.8x ↓		
13: 10.8x ↖	18: 10.3 ↗	Total	199
14: 10.8x ↘	19: 10.8x ↓		
15: 9.9 ↖	20: 10.5 ↘		

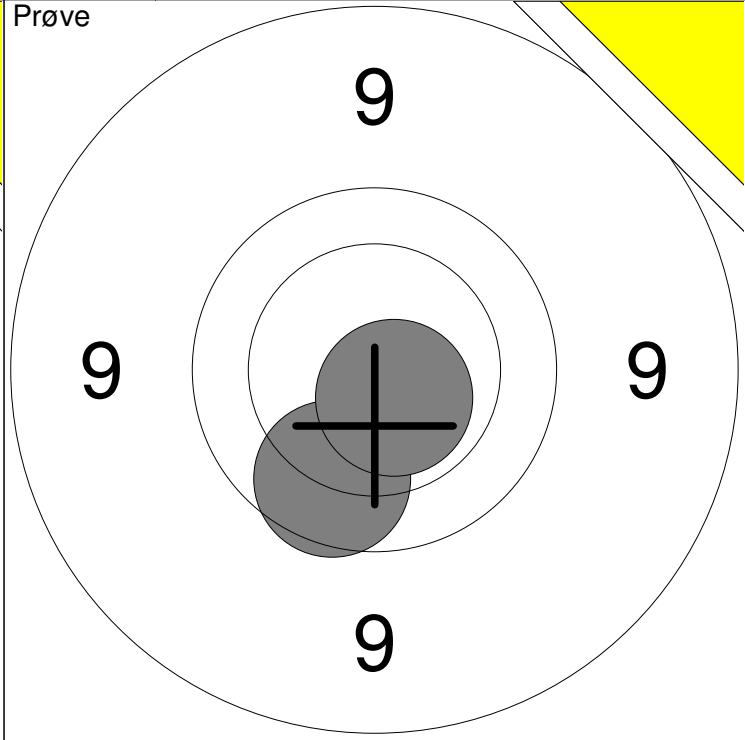
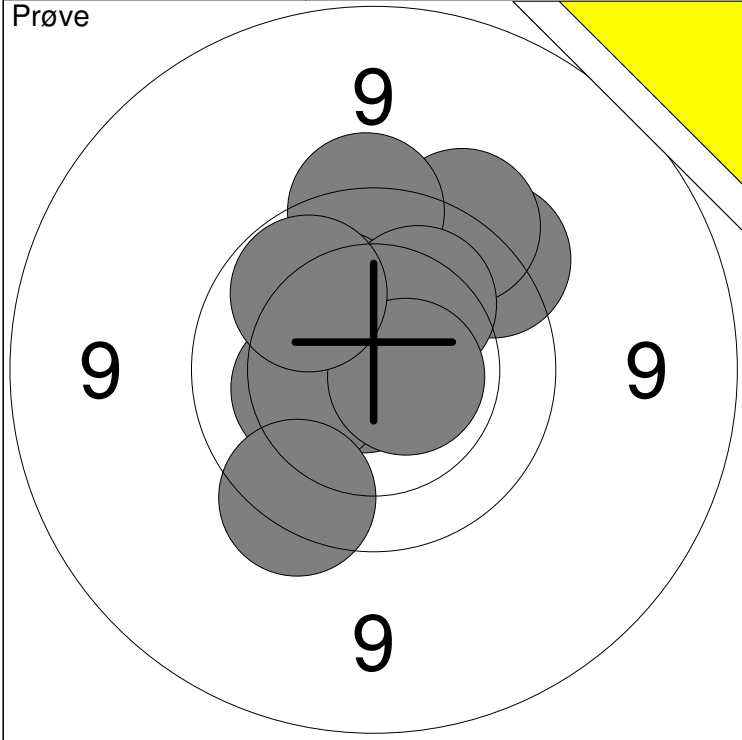

1: 9.6 ↗	6: 10.8x ←	Serie	96
2: 9.6 ↗	7: 10.3 ←		
3: 9.6 ↑	8: 10.6x →	Total	0
4: 10.2 ↖	9: 10.0 ↖		
5: 10.2 ↗	10: 9.7 ↘		

11: 9.9 ↘	Serie	19
12: 10.6x ↘		
Total		0

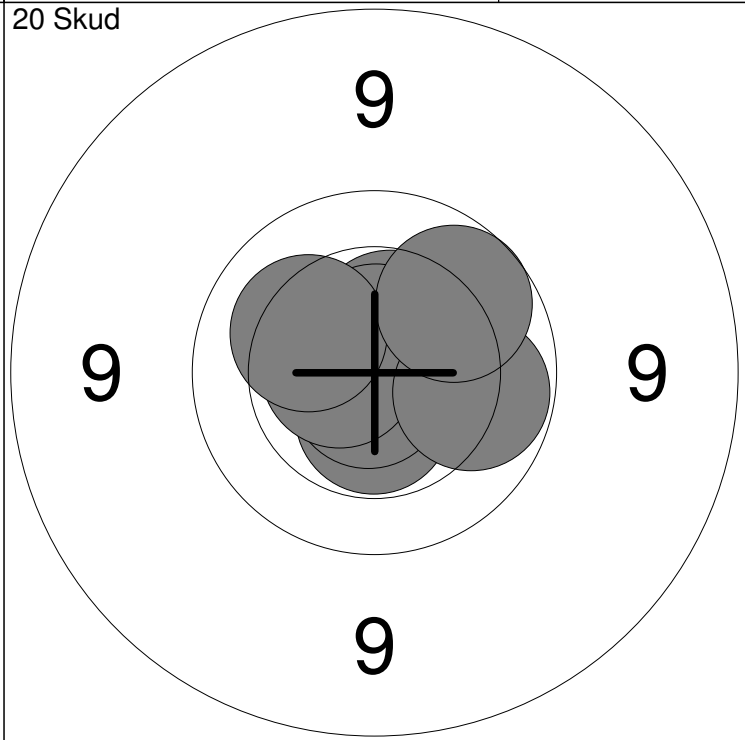
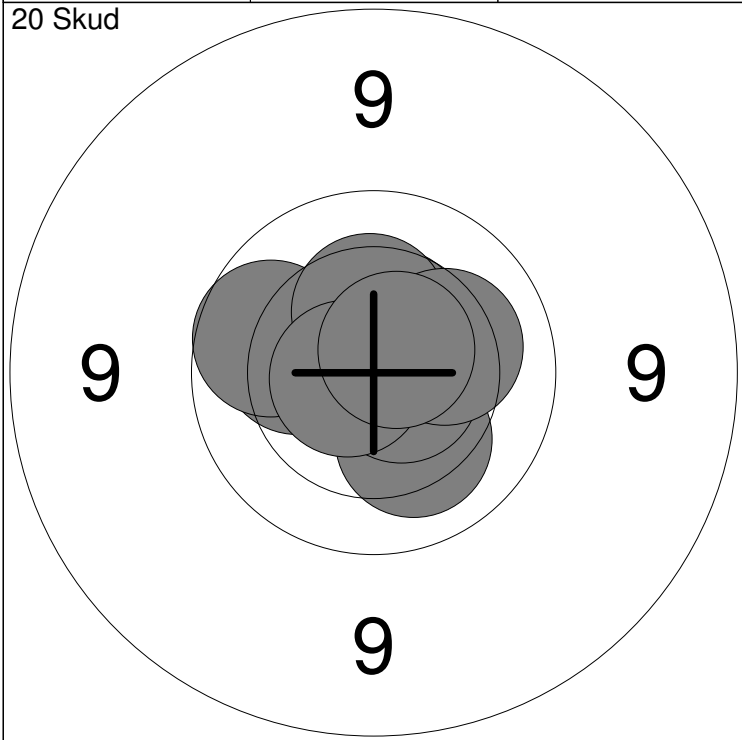

1: 10.2 ←	6: 9.9 ←	Serie	99
2: 10.7x ↗	7: 10.4 ↑		
3: 10.2 ↘	8: 10.2 →	Total	99
4: 10.5 ↑	9: 10.7x ←		
5: 10.7x →	10: 10.6x ↗		

11: 10.8x ↘	16: 10.7x ↑	Serie	99
12: 10.5x ↘	17: 10.6x ←		
13: 10.6x →	18: 10.2 ←	Total	198
14: 10.5x ↑	19: 10.0 →		
15: 10.8x ↘	20: 9.9 ↗		

Hold	Skive	Trine Herskind		
6	9			
AAS		Vodskov Skytteforening	J2	
		Jyllandsstævne 2016	Aalborg Skyttekreds	
Prøve		1:	9.2	←
		2:	9.0	←
		3:	10.2	←
		4:	10.3	↗
		5:	10.5	←
		6:	10.5	↗
		7:	9.8	→
		8:	10.7x	↙
		9:	9.9	↑
		10:	10.4	↑
		Serie		96.0
Total		0.0		
20 Skud		1:	10.4	↖
		2:	10.2	←
		3:	10.8x	↑
		4:	10.5	←
		5:	10.7x	↙
		6:	10.7x	↗
		7:	10.4	↗
		8:	10.6x	←
		9:	10.5	→
		10:	10.1	↑
		Serie		100.0
Total		100.0		
20 Skud		11:	10.6	↗
		12:	10.8x	↙
		13:	10.2	→
		14:	10.6x	↗
		15:	10.5	↑
		16:	10.6x	↙
		17:	10.1	↑
		18:	10.5	↙
		19:	10.7x	↗
		20:	10.2	↑
		Serie		100.0
Total		200.0		

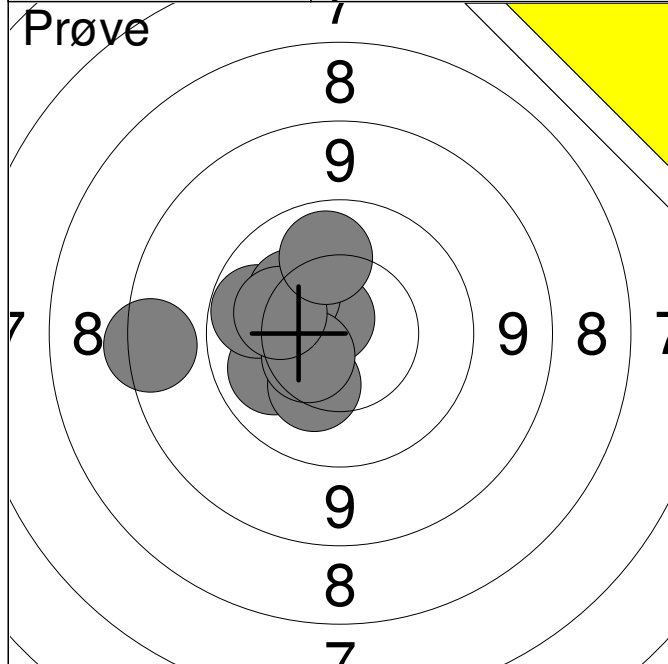

1:	8.6	←
2:	10.1	↙
3:	10.3	↘
4:	10.7x	↗
5:	10.0	↖
6:	10.3	↗
7:	10.5	↙
8:	10.2	↖
9:	10.1	↗
<b>Serie</b>		<b>88.0</b>
<b>Total</b>		<b>0.0</b>

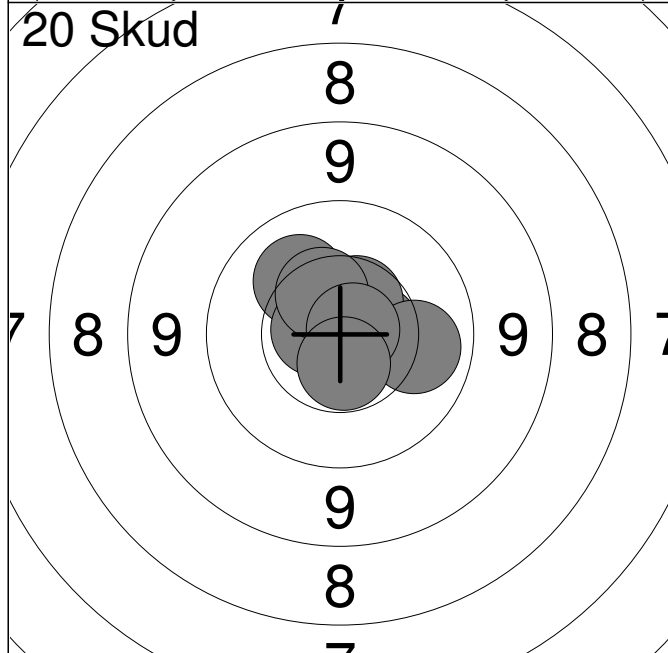

1:	10.7x	↗
2:	10.8x	→
3:	10.6	→
4:	10.2	↗
5:	10.5	↖
6:	10.1	→
7:	10.7x	←
8:	10.4	↖
9:	10.8x	→
10:	10.6x	↓
<b>Serie</b>		<b>100.0</b>
<b>Total</b>		<b>100.0</b>

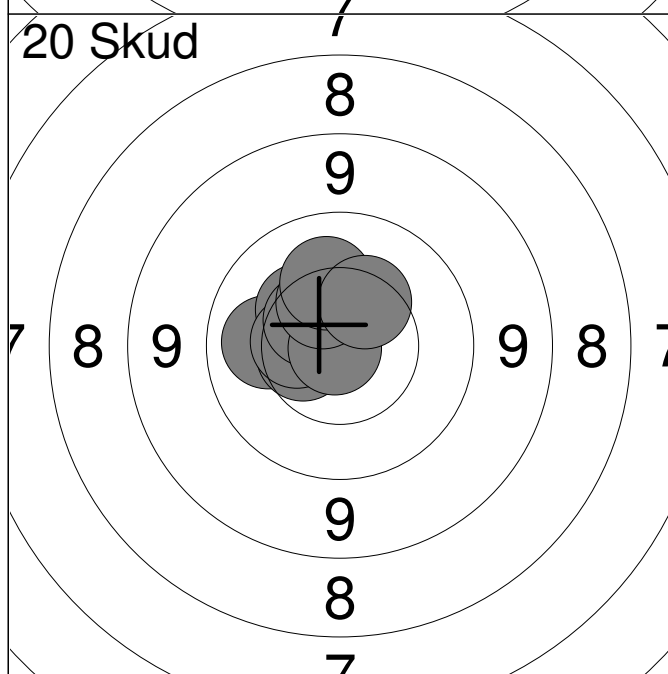

11:	10.6x	↑
12:	10.1	←
13:	10.5	←
14:	10.3	↗
15:	10.5	←
16:	10.5	↗
17:	10.9x	↙
18:	10.4	↖
19:	10.2	↖
20:	10.4	↗
<b>Serie</b>		<b>100.0</b>
<b>Total</b>		<b>200.0</b>

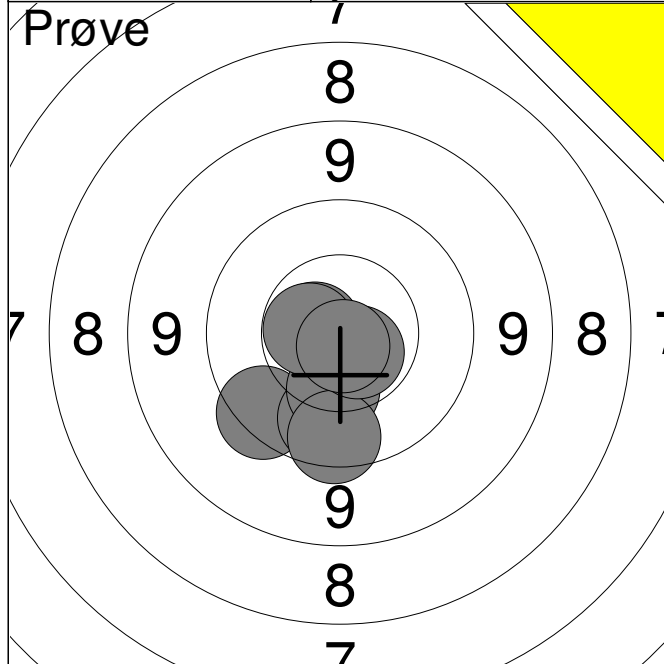

1:	9.6	↙
2:	10.7x	←
3:	10.0	↓
4:	10.3	↓
5:	9.7	↓
6:	10.6x	←
7:	10.7x	↘
8:	10.8x	↓
<b>Serie</b>		<b>78.0</b>
<b>Total</b>		<b>0.0</b>

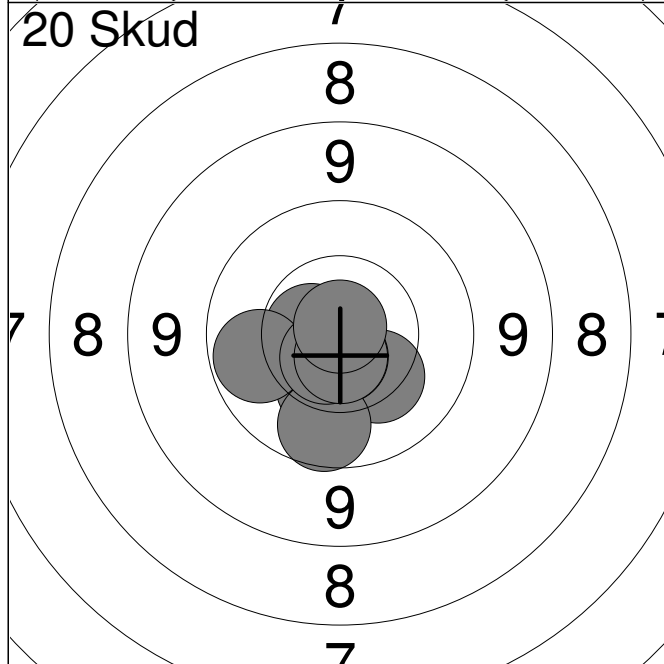

1:	10.7x	←
2:	10.3	↓
3:	10.3	↘
4:	10.7x	↓
5:	9.9	↓
6:	10.6x	←
7:	10.0	←
8:	10.6x	↓
9:	10.7x	↓
10:	10.9x	↑
<b>Serie</b>		<b>99.0</b>
<b>Total</b>		<b>99.0</b>

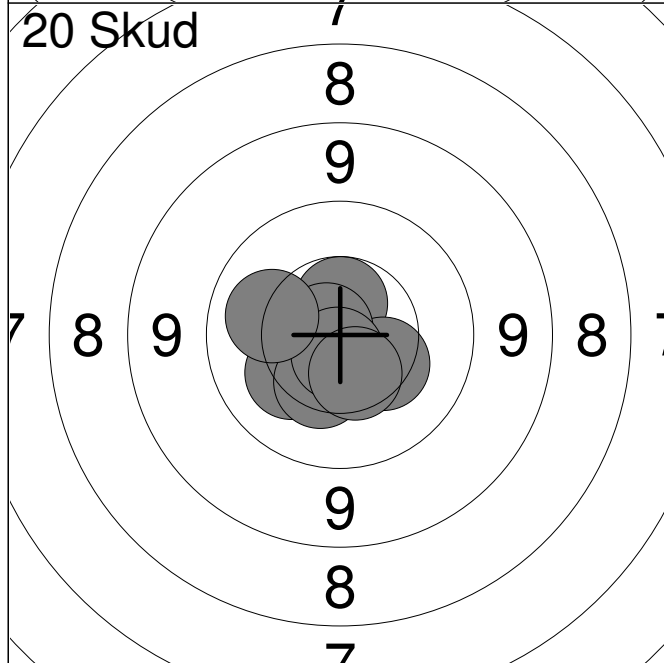

11:	10.6	↑
12:	10.3	↘
13:	10.7x	↓
14:	10.2	↙
15:	10.7x	↓
16:	10.8x	↖
17:	10.4	↓
18:	10.7x	↓
19:	10.5	↘
20:	10.1	←
<b>Serie</b>		<b>100.0</b>
<b>Total</b>		<b>199.0</b>



Hold	Skive	Gunnar Jensen	
6	12	AAS	Løgstør Sportsskytteklub
		Jyllandsstævne 2016	Aalborg Skyttekreds
Prøve			
	1:	8.9	→
	2:	9.7	→
	3:	10.3	↓
	4:	10.4	↓
	5:	10.1	↗
	6:	9.8	↗
	7:	9.7	↗
	8:	9.8	↖
	9:	10.6x	→
	10:	10.1	↘
	Serie		94.0
Total		0.0	
	1:	10.7x	↗
	2:	9.8	←
	3:	10.1	↗
	4:	10.1	←
	5:	10.5x	→
	6:	9.7	←
	7:	10.0	↓
	8:	9.7	→
	9:	10.0	↑
	10:	10.4	→
	Serie		97.0
Total		97.0	
	11:	10.1	↗
	12:	10.2	↗
	13:	10.3	↓
	14:	10.5x	↗
	15:	10.3	→
	16:	10.4	↑
	17:	10.4	→
	18:	9.8	↗
	19:	9.4	→
	20:	10.5x	↑
	Serie		98.0
Total		195.0	

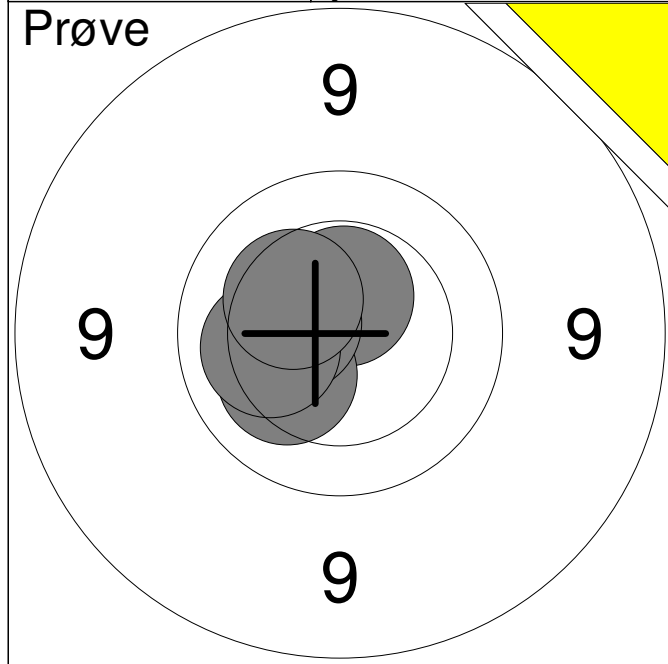

1:	10.5x	↑
2:	10.2	↙
3:	10.4	←
4:	10.2	↙
5:	10.3	↖
<b>Serie</b>		<b>50.0</b>
<b>Total</b>		<b>0.0</b>

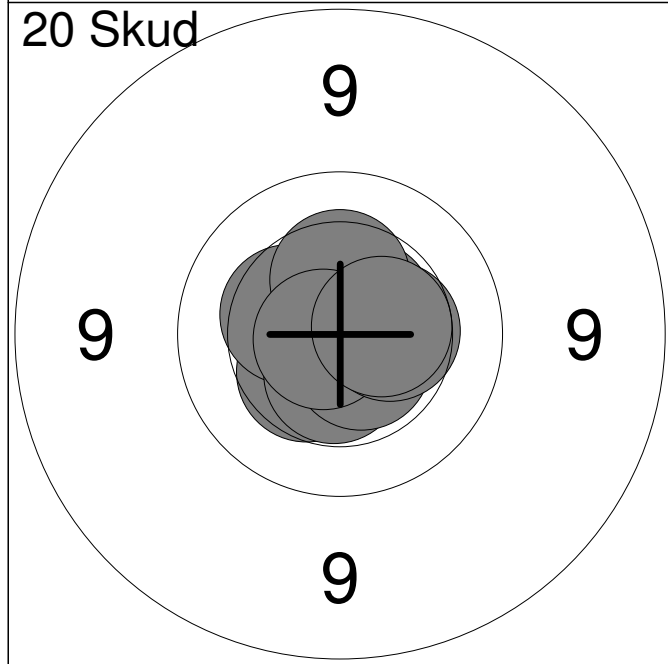

1:	10.4	↙
2:	10.4	↖
3:	10.6x	↗
4:	10.7x	↑
5:	10.5x	↓
6:	10.4	↑
7:	10.6x	↘
8:	10.8x	←
9:	10.4	→
10:	10.5	→
<b>Serie</b>		<b>100.0</b>
<b>Total</b>		<b>100.0</b>

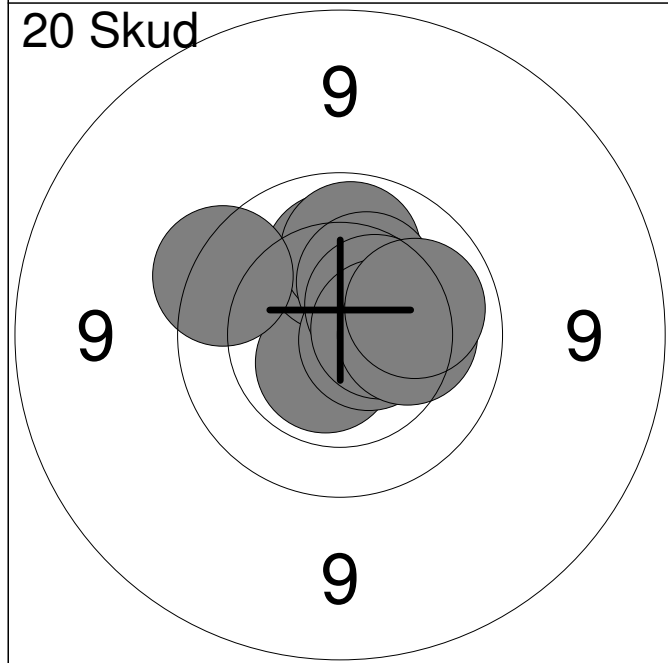

11:	10.6x	↙
12:	10.2	↑
13:	10.0	↑
14:	10.3	↗
15:	10.6x	→
16:	10.5	↗
17:	10.5x	→
18:	10.2	→
19:	10.1	↗
20:	9.7	↖
<b>Serie</b>		<b>99.0</b>
<b>Total</b>		<b>199.0</b>

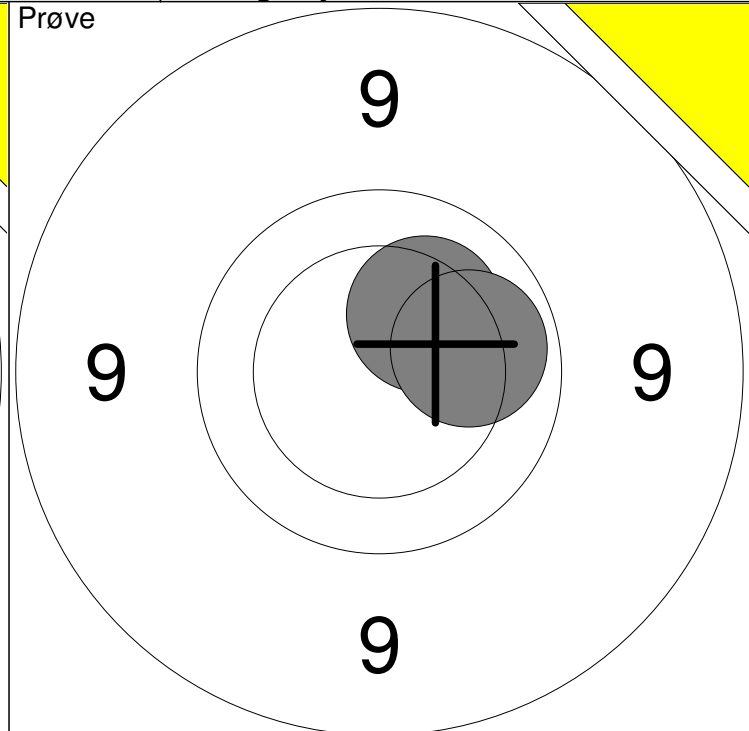
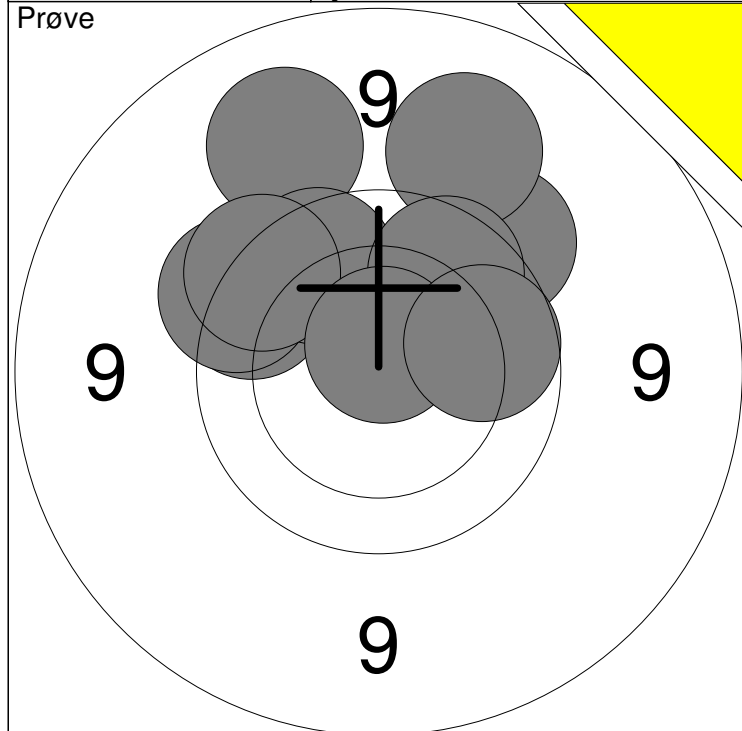

1: 9.2 ↗	6: 9.2 ↗	Serie	91
2: 9.7 ↖	7: 9.9 ↗		
3: 9.6 ↗	8: 9.7 ↖	Total	0
4: 9.9 ↗	9: 10.7x ↗		
5: 9.6 ↖	10: 9.9 →		

11: 10.2 ↗	Serie	20
12: 10.1 →		
Total		0

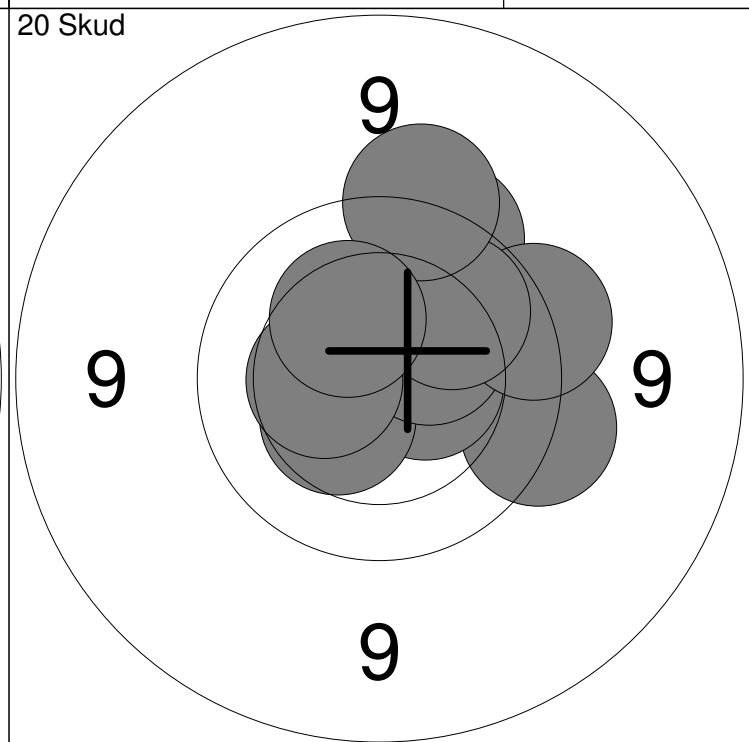
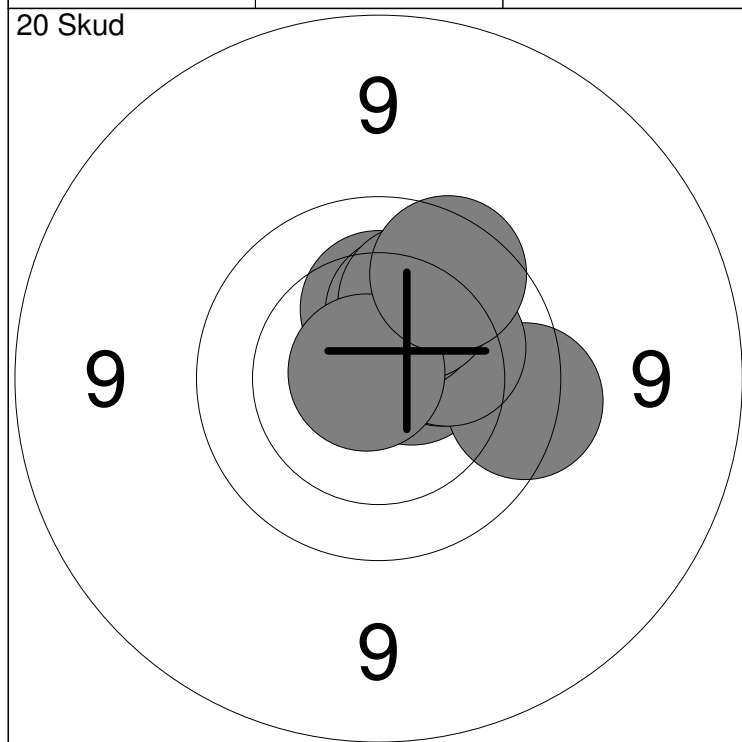

1: 10.6x →	6: 10.2 →	Serie	98
2: 9.7 →	7: 10.3 ↗		
3: 10.3 ↗	8: 10.1 ↗	Total	98
4: 10.3 ↗	9: 10.8x ↖		
5: 10.3 →	10: 9.8 ↗		

11: 9.6 →	16: 9.6 →	Serie	96
12: 10.5x →	17: 10.0 ↗		
13: 10.4 ↖	18: 9.5 ↗	Total	194
14: 9.7 ↗	19: 10.4 ←		
15: 10.4 →	20: 10.3 ↖		

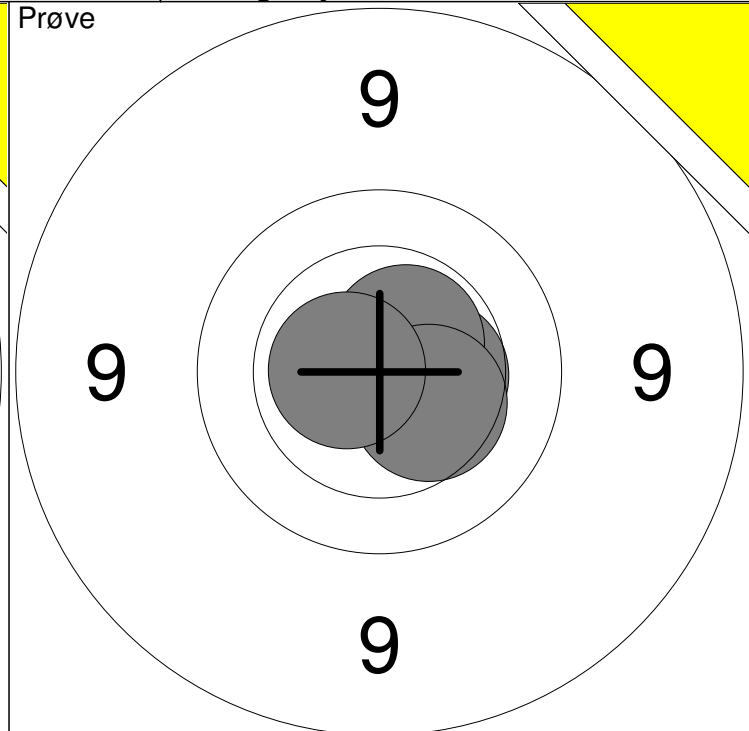
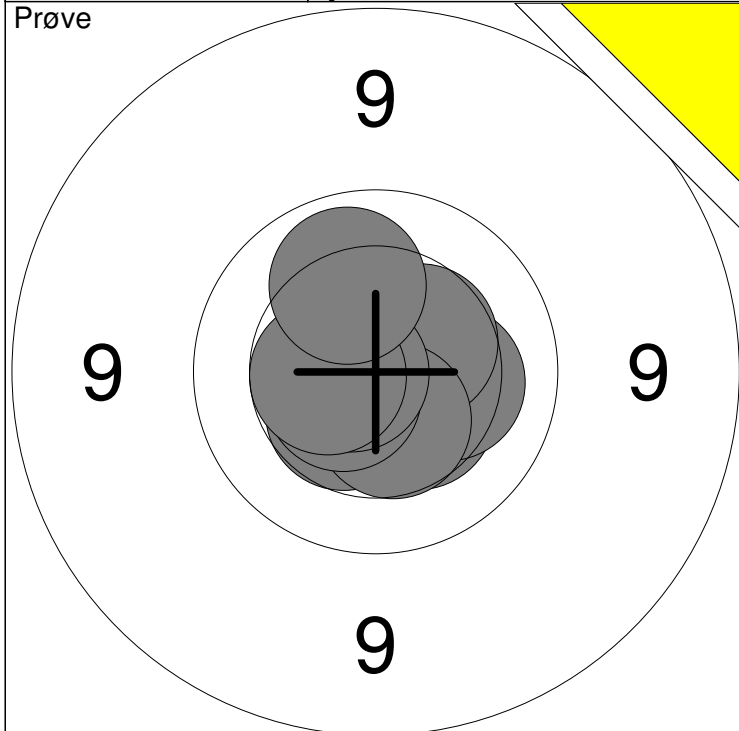

1: 10.4 ↘	6: 10.5 ↓	Serie	100
2: 10.5 ↙	7: 10.6x ↙		
3: 10.7x ↓	8: 10.7x ←	Total	0
4: 10.3 →	9: 10.5x ←		
5: 10.4 ↗	10: 10.1 ↑		

11: 10.5 →	Serie	40
12: 10.6x ↗		
13: 10.4 ↘	Total	0
14: 10.6x ←		

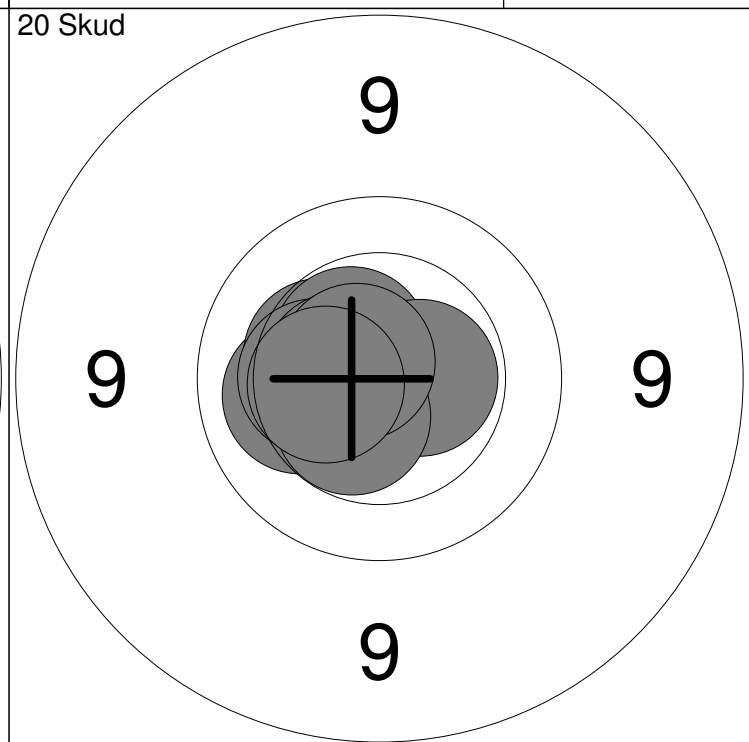
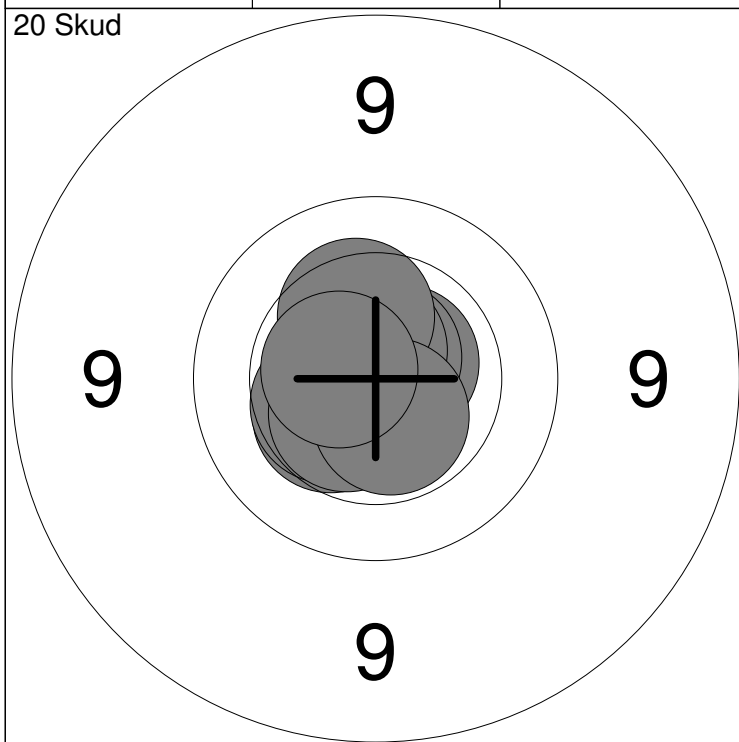

1: 10.7x ↗	6: 10.5x ↙	Serie	100
2: 10.7x ↑	7: 10.7x ↑		
3: 10.4 ↙	8: 10.3 ↑	Total	100
4: 10.8x ↖	9: 10.6x ↓		
5: 10.4 ↙	10: 10.6x ←		

11: 10.2 ←	16: 10.5x ↙	Serie	100
12: 10.4 ↖	17: 10.3 ←		
13: 10.5x ↗	18: 10.6x ↖	Total	200
14: 10.8x ↙	19: 10.7x ↖		
15: 10.6x →	20: 10.4 ←		

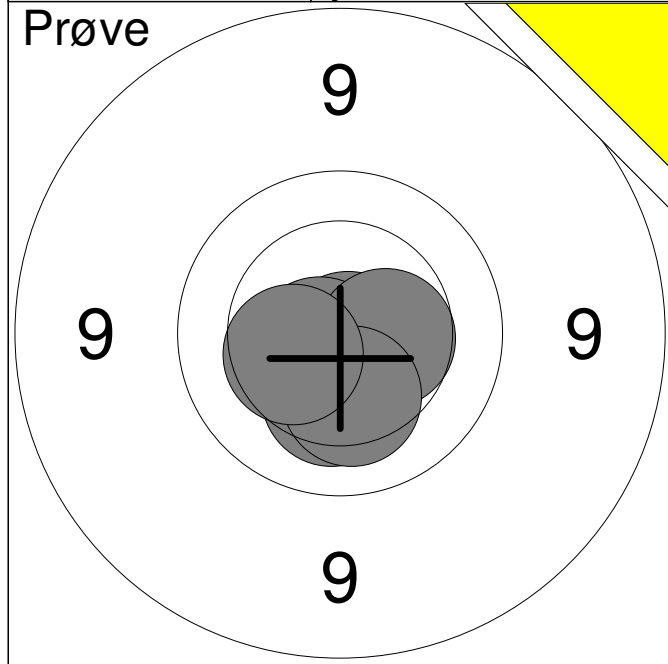

1:	10.8x	↘
2:	10.7x	↙
3:	10.5	→
4:	10.3	↓
5:	10.3	↓
6:	10.4	↙
<b>Serie</b>		<b>60.0</b>
<b>Total</b>		<b>0.0</b>

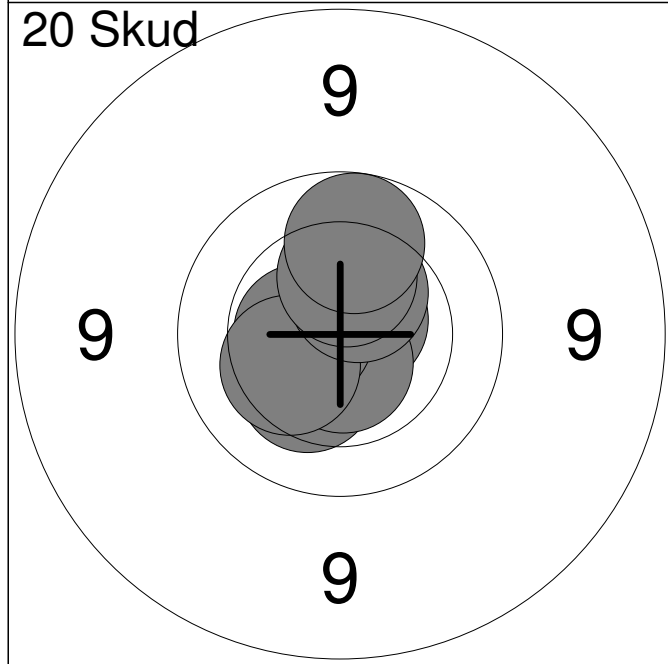

1:	10.3	↙
2:	10.8x	↖
3:	10.7x	↑
4:	10.7x	↗
5:	10.6x	↓
6:	10.6x	←
7:	10.3	↙
8:	10.5	↗
9:	10.3	↑
10:	10.0	↑
<b>Serie</b>		<b>100.0</b>
<b>Total</b>		<b>100.0</b>

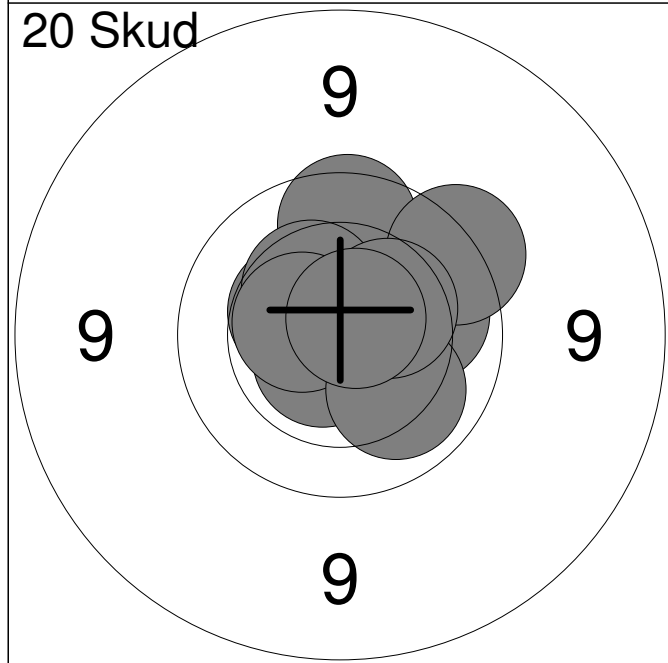

11:	10.1	→
12:	10.4	↙
13:	10.6x	↙
14:	9.8	↑
15:	10.4	↖
16:	10.5x	↙
17:	10.1	↘
18:	9.7	↗
19:	10.4	↗
20:	10.7x	↗
<b>Serie</b>		<b>98.0</b>
<b>Total</b>		<b>198.0</b>

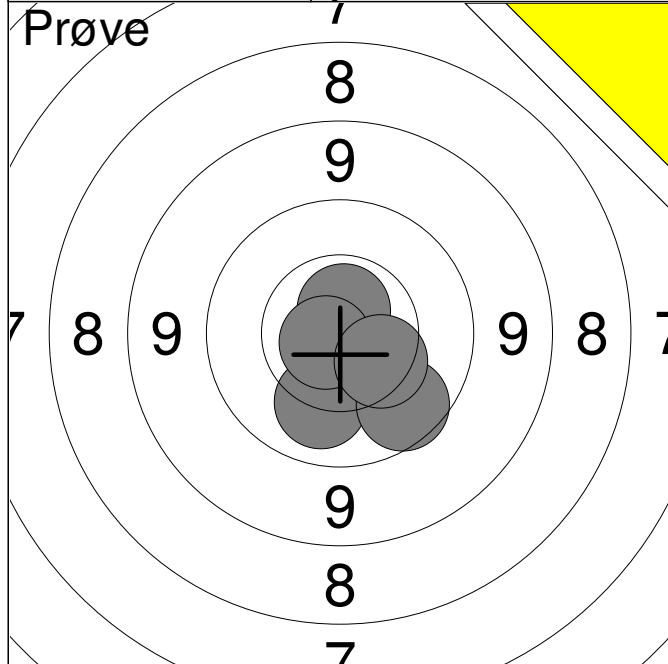

1:	10.1	↓
2:	9.8	↘
3:	10.7x	↑
4:	10.8x	↙
5:	10.4	↘
<b>Serie</b>		<b>49.0</b>
<b>Total</b>		<b>0.0</b>

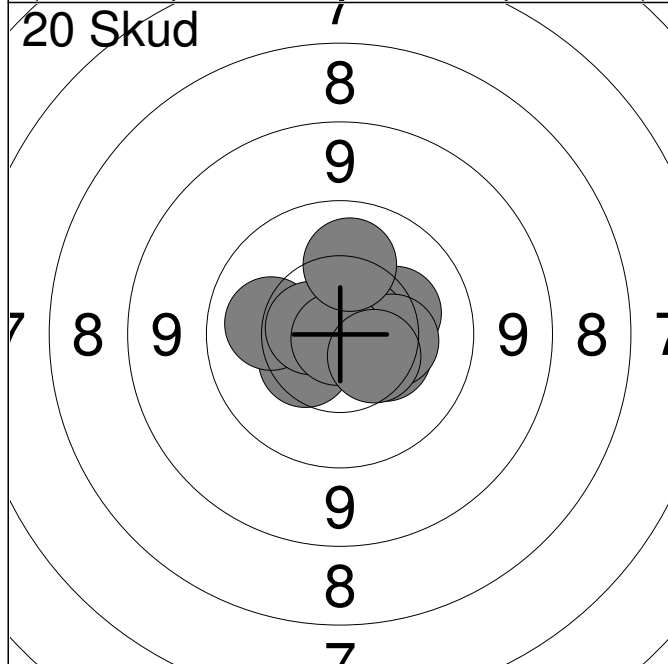

1:	10.4	↙
2:	10.1	←
3:	10.4	→
4:	10.6x	←
5:	10.3	→
6:	10.7x	→
7:	10.3	→
8:	10.9x	↓
9:	10.1	↑
10:	10.5	↘
<b>Serie</b>		<b>100.0</b>
<b>Total</b>		<b>100.0</b>

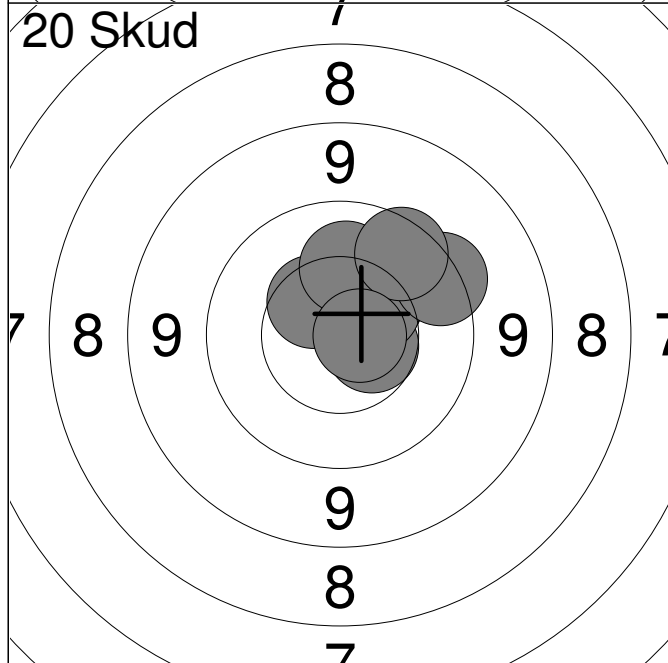

11:	10.3	↗
12:	10.6	→
13:	10.4	↗
14:	10.6x	↗
15:	10.0	↗
16:	10.5	↖
17:	9.6	→
18:	10.2	↑
19:	9.8	↗
20:	10.7x	→
<b>Serie</b>		<b>98.0</b>
<b>Total</b>		<b>198.0</b>

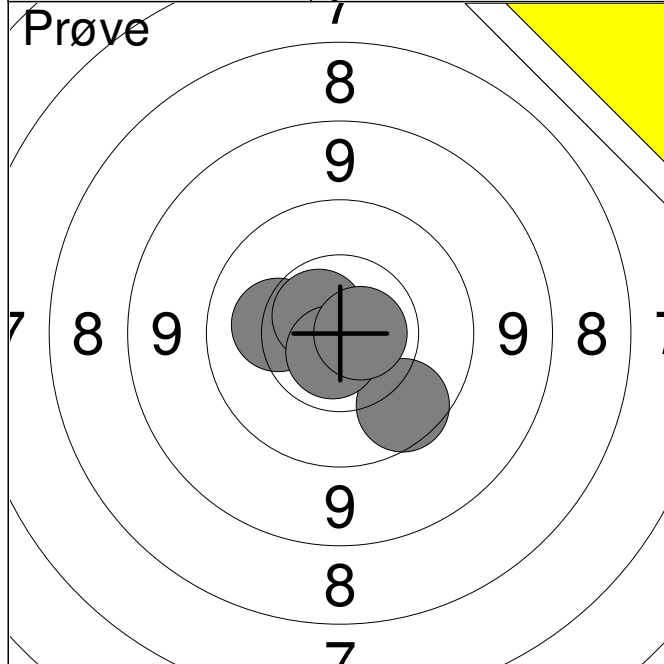

1:	10.8x	↙
2:	9.8	↘
3:	10.2	←
4:	10.6x	↗
5:	10.7x	↘
6:	10.7x	→
<b>Serie</b>		<b>59.0</b>
<b>Total</b>		<b>0.0</b>

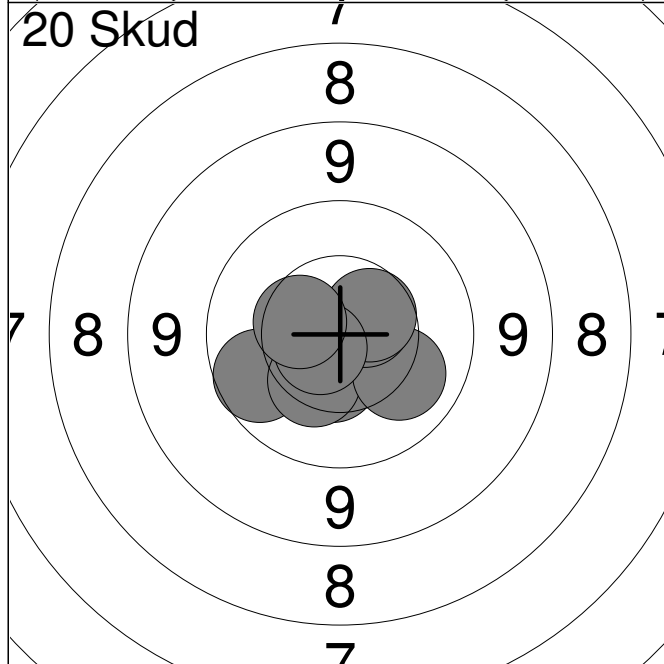

1:	10.4	↙
2:	10.6x	↙
3:	10.5	↓
4:	9.9	↙
5:	10.3	↘
6:	10.1	↘
7:	10.6x	↗
8:	10.5	↗
9:	10.7x	↙
10:	10.5	↙
<b>Serie</b>		<b>99.0</b>
<b>Total</b>		<b>99.0</b>

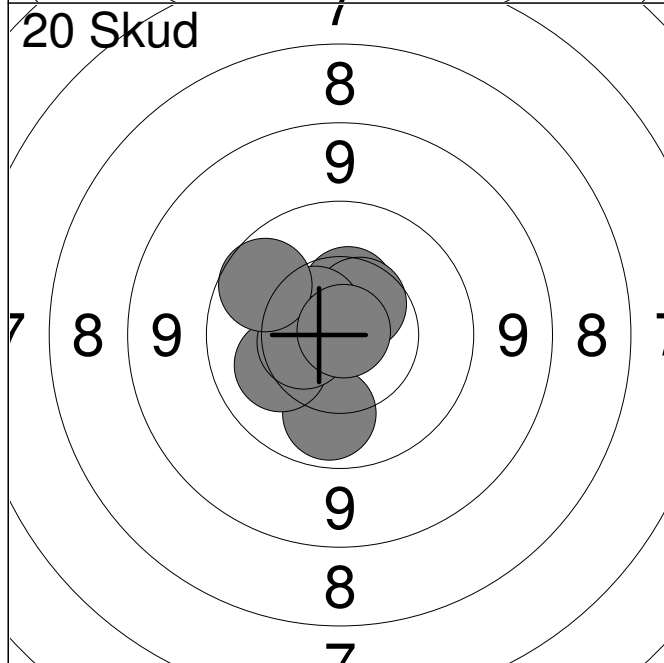

11:	10.5	↑
12:	10.7x	←
13:	10.5	↗
14:	10.4	↙
15:	10.0	↓
16:	10.2	↙
17:	10.6	↗
18:	10.5	←
19:	9.9	↗
20:	10.9x	↗
<b>Serie</b>		<b>99.0</b>
<b>Total</b>		<b>198.0</b>

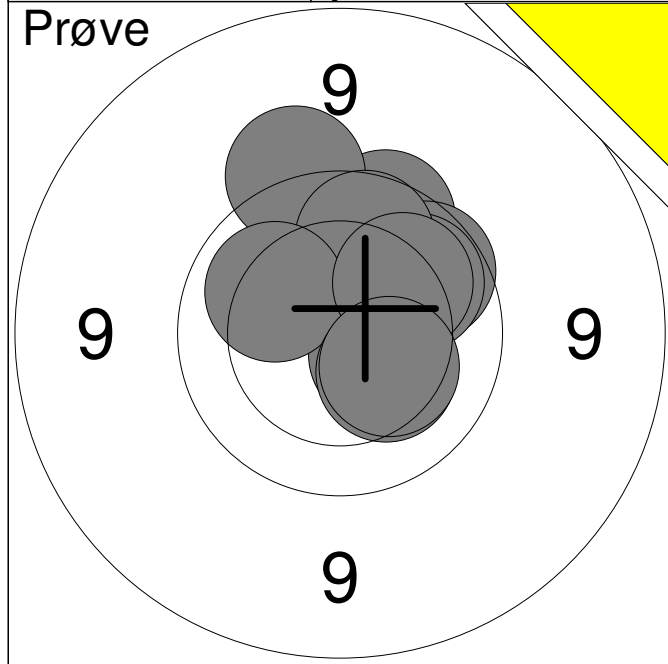

1:	9.8	↗
2:	10.5	↘
3:	9.9	↗
4:	10.0	↗
5:	9.5	↗
6:	9.9	↗
7:	10.1	↗
8:	10.3	↘
9:	10.1	↗
10:	10.3	↘
<b>Serie</b>		<b>96.0</b>
<b>Total</b>		<b>0.0</b>

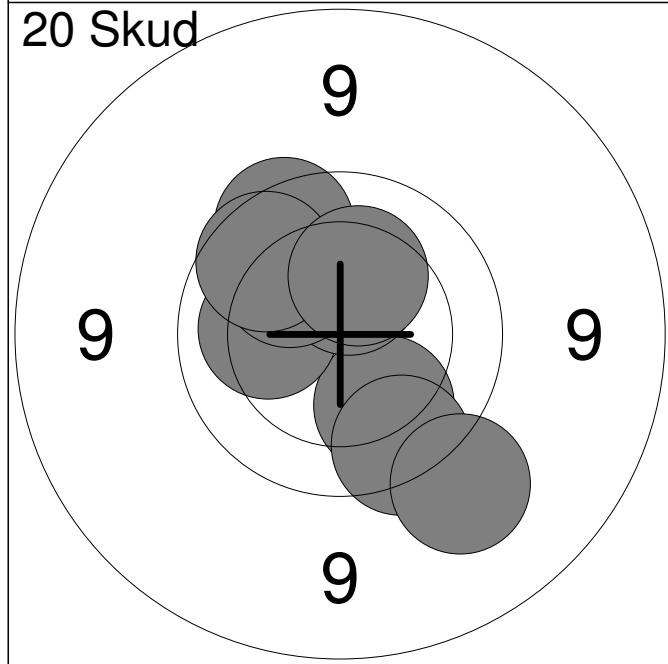

1:	10.1	↘
2:	9.7	↘
3:	10.2	←
4:	10.4	↗
5:	10.4	↗
6:	10.1	↗
7:	9.8	↗
8:	9.9	↗
9:	10.3	↗
10:	9.3	↘
<b>Serie</b>		<b>96.0</b>
<b>Total</b>		<b>96.0</b>

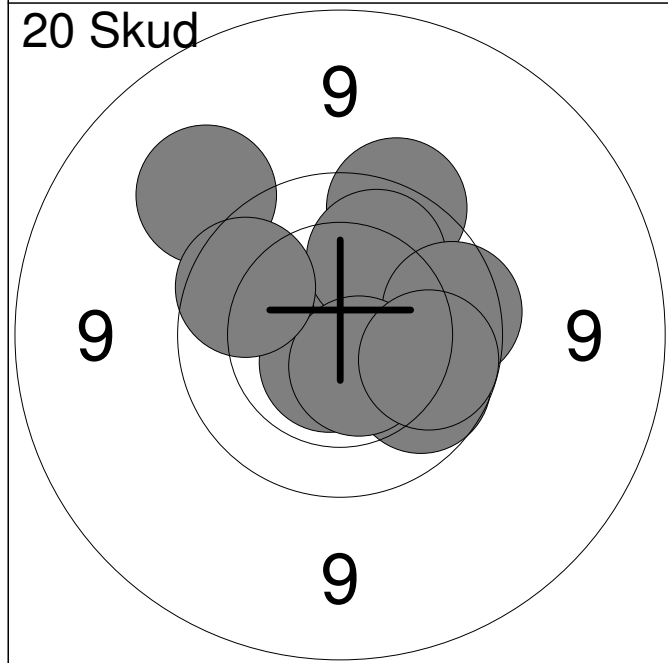

11:	10.6x	↘
12:	9.7	↗
13:	9.3	↗
14:	10.3	↗
15:	10.0	↗
16:	9.9	↘
17:	9.8	→
18:	10.6x	↘
19:	9.9	↗
20:	10.0	→
<b>Serie</b>		<b>95.0</b>
<b>Total</b>		<b>191.0</b>



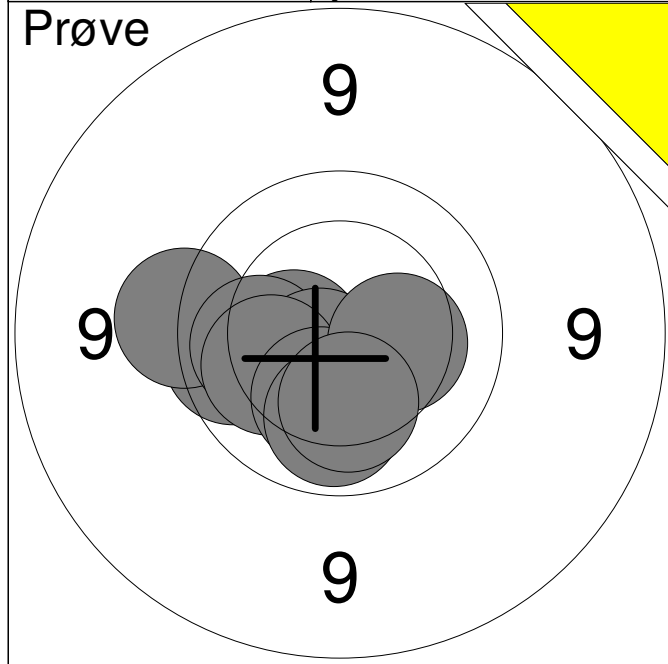

1:	9.8	←
2:	10.4	←
3:	9.6	←
4:	10.1	←
5:	10.6x	↙
6:	10.1	←
7:	10.2	↓
8:	10.0	↓
9:	10.3	→
10:	10.2	↓
<b>Serie</b>		<b>98.0</b>
<b>Total</b>		<b>0.0</b>

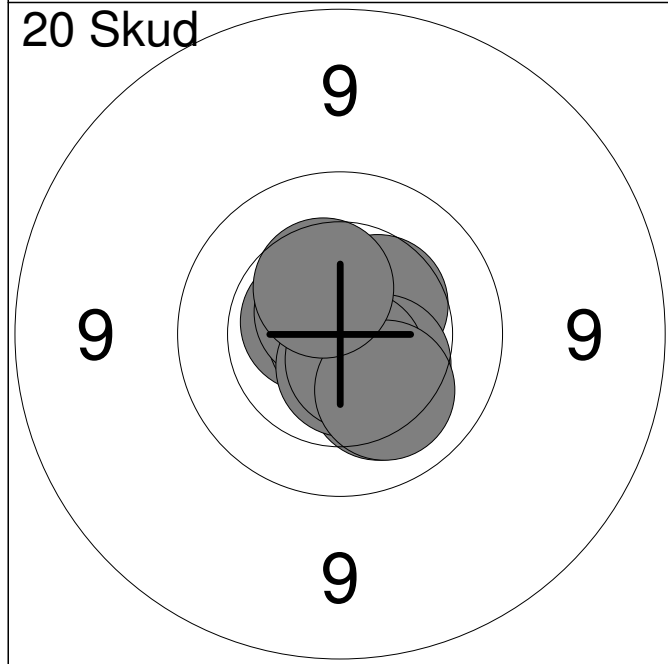

1:	10.6x	↖
2:	10.9x	←
3:	10.7x	↗
4:	10.4	↗
5:	10.2	↓
6:	10.6x	↓
7:	10.4	↓
8:	10.6x	↓
9:	10.2	↓
10:	10.4	↗
<b>Serie</b>		<b>100.0</b>
<b>Total</b>		<b>100.0</b>

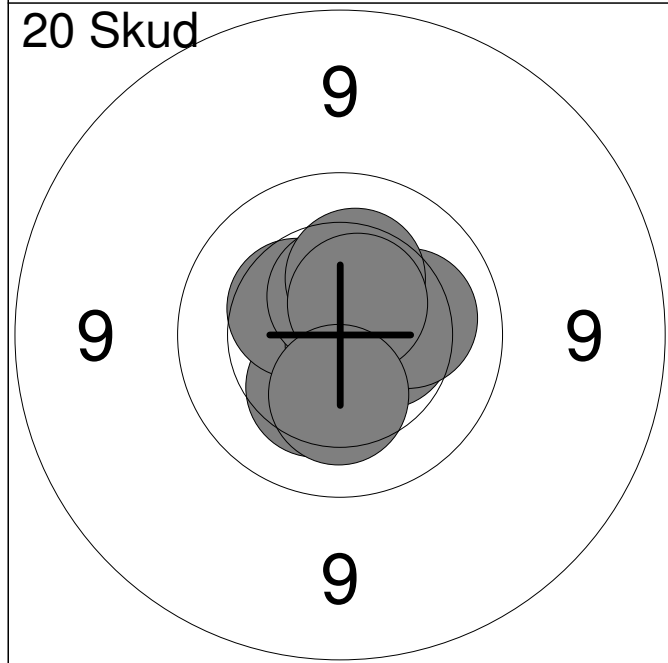

11:	10.3	↙
12:	10.4	↗
13:	10.5	→
14:	10.4	↗
15:	10.8x	↙
16:	10.5x	↑
17:	10.2	→
18:	10.3	↑
19:	10.6x	↗
20:	10.3	↓
<b>Serie</b>		<b>100.0</b>
<b>Total</b>		<b>200.0</b>

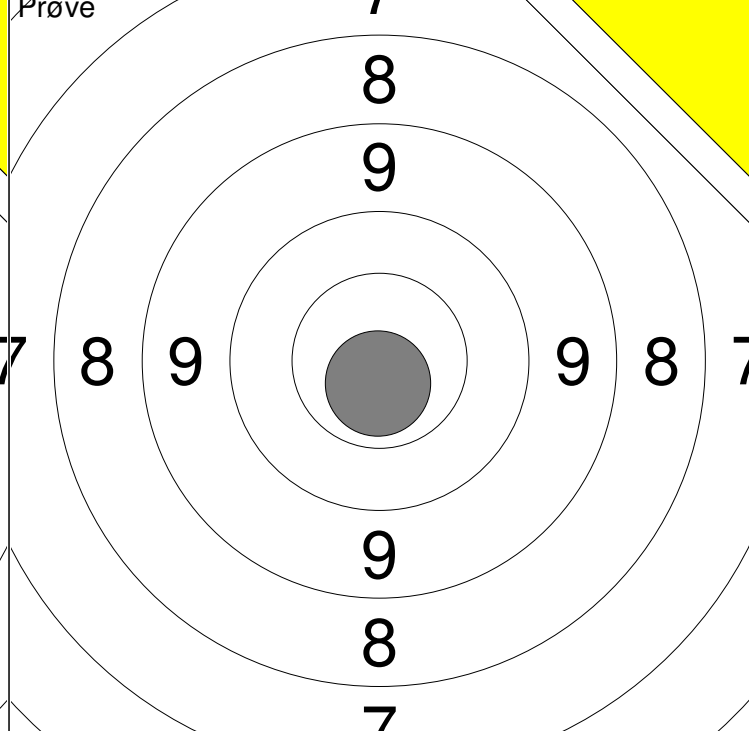
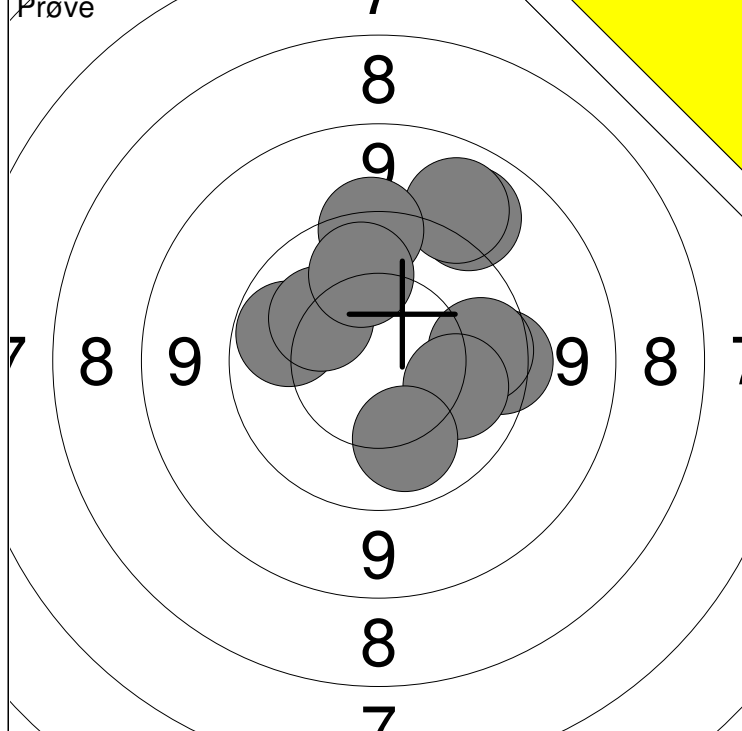

1: 9.7 →	6: 10.1 ↓	Serie 95	
2: 9.1 ↗	7: 10.0 ←		
3: 9.9 →	8: 9.6 ↑	Total 0	
4: 9.1 ↗	9: 10.2 ↖		
5: 10.1 →	10: 10.0 ↑		

11: 10.7x ↓		Serie 10	
		Total 0	

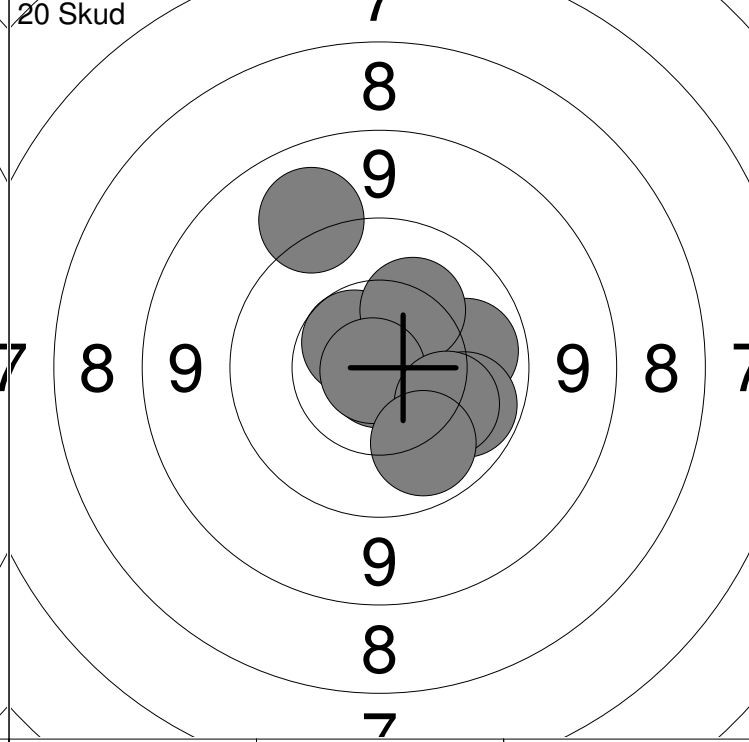
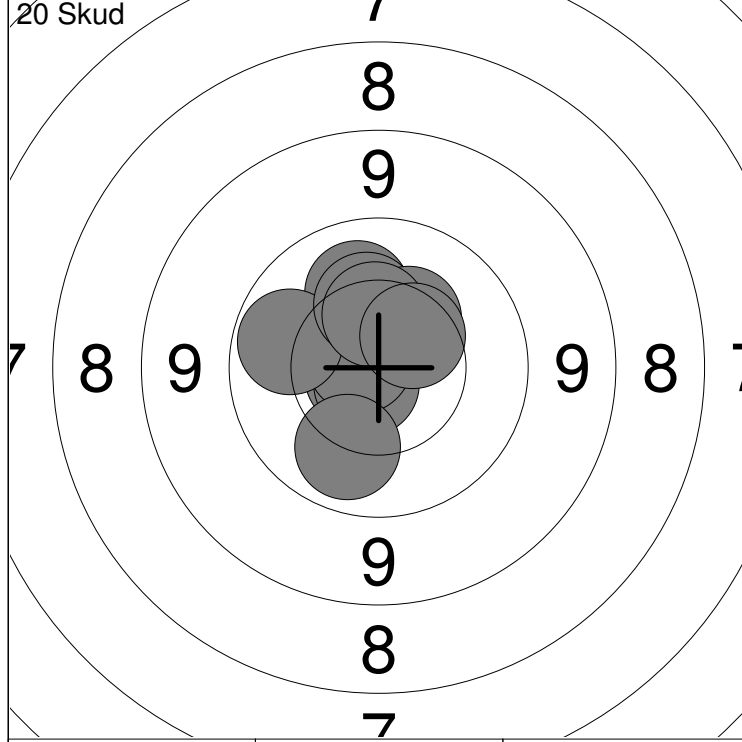

1: 10.7x ←	6: 10.1 ↓	Serie 100	
2: 10.7x ↘	7: 10.3 ↑		
3: 10.7x ←	8: 10.4 ↗	Total 100	
4: 10.2 ↑	9: 10.4 ↑		
5: 10.0 ←	10: 10.5 ↗		

11: 10.9x ↓	16: 9.2 ↗	Serie 99	
12: 10.6 →	17: 10.0 →		
13: 10.0 →	18: 10.9x ←	Total 199	
14: 10.6x ↖	19: 10.2 ↘		
15: 10.3 ↗	20: 10.0 ↓		

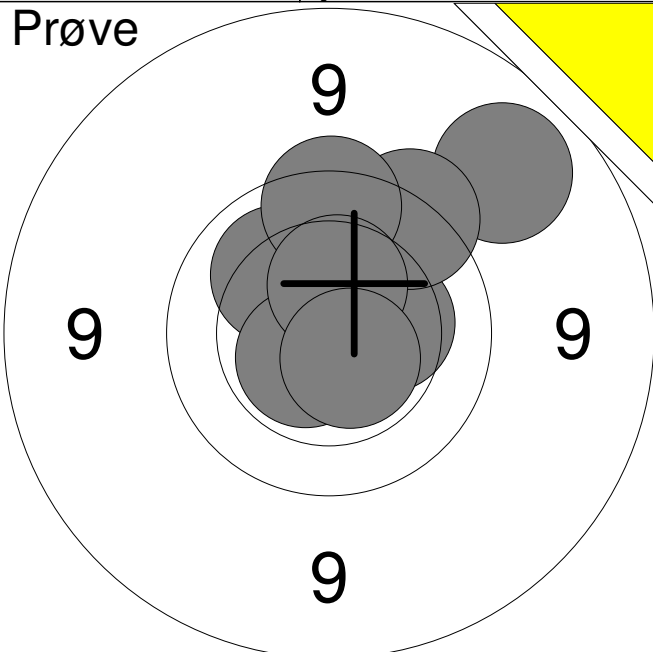
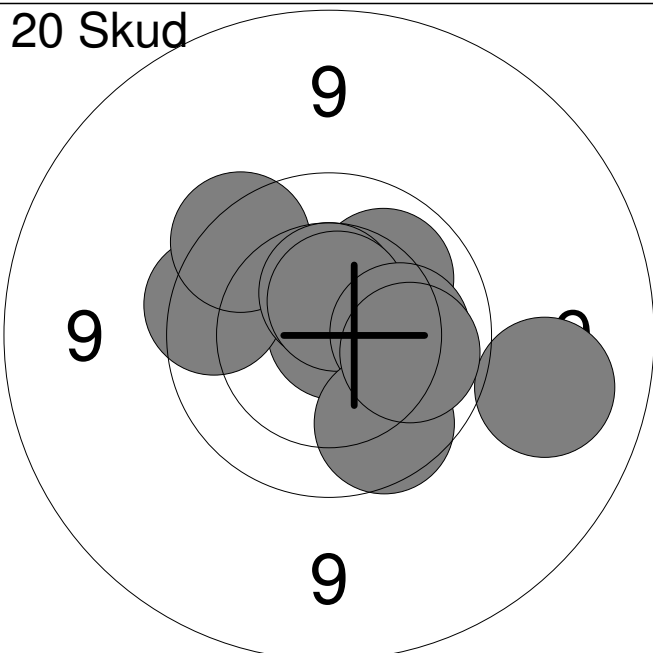
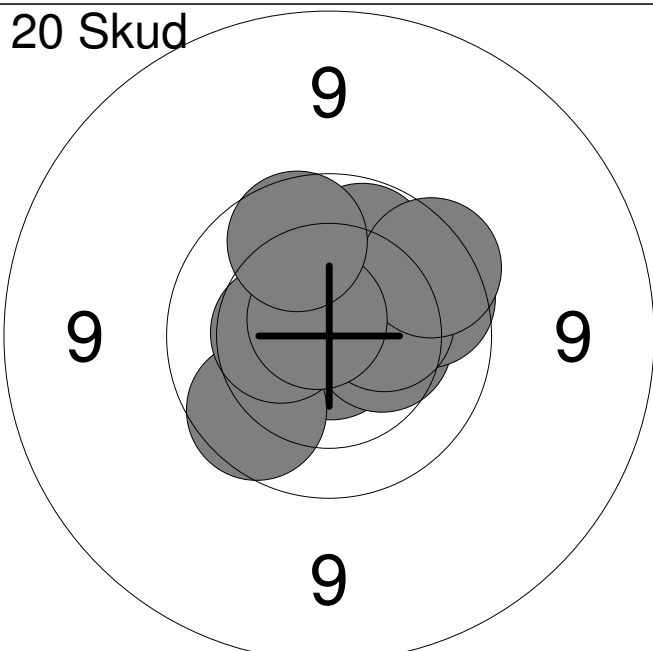
Hold	Skive	Kaj Haulrich	
8	3	Vodskov Skytteforening	SE2
AAS	Jyllandsstævne 2016	Aalborg Skyttekreds	
<b>Prøve</b> 	1:	9.1	↗
	2:	10.3	→
	3:	10.8x	↑
	4:	10.1	↖
	5:	10.6x	↙
	6:	9.7	↗
	7:	9.7	↑
	8:	10.4	↑
	9:	10.6x	↘
	Serie		87.0
Total		0.0	
<b>20 Skud</b> 	1:	10.8x	↗
	2:	9.8	←
	3:	9.7	↖
	4:	10.1	↗
	5:	10.5	↑
	6:	10.6x	↑
	7:	10.2	→
	8:	9.2	→
	9:	9.9	↘
	10:	10.1	→
Serie		96.0	
Total		96.0	
<b>20 Skud</b> 	11:	10.8x	↓
	12:	10.4	→
	13:	9.9	↙
	14:	10.4	←
	15:	9.9	↗
	16:	10.0	↑
	17:	10.3	→
	18:	9.8	↗
	19:	10.7x	↖
	20:	9.9	↑
Serie		96.0	
Total		192.0	

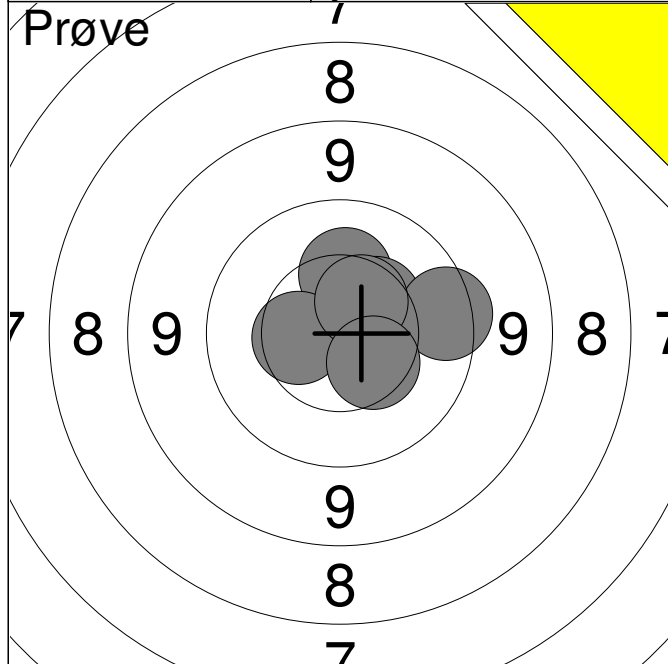

1:	10.3	↑
2:	10.4	↗
3:	9.7	→
4:	10.5	←
5:	10.5	↖
6:	10.4	↘
<b>Serie</b>		<b>59.0</b>
<b>Total</b>		<b>0.0</b>

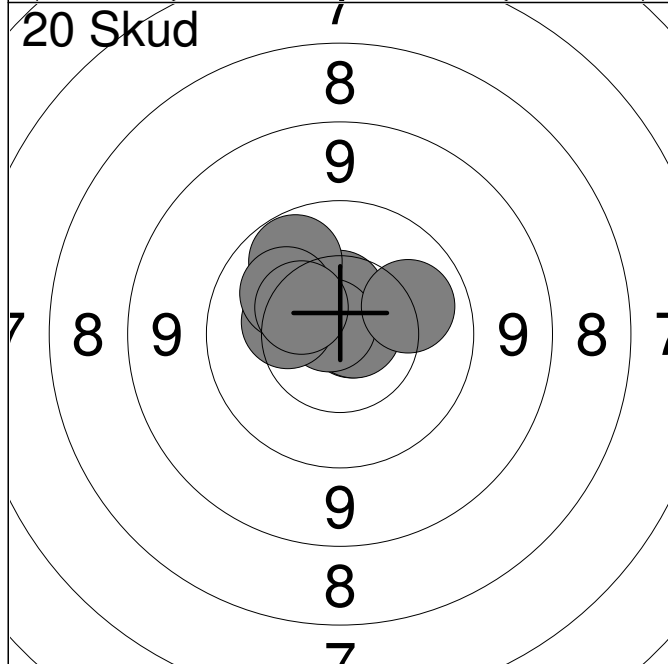

1:	10.6x	↑
2:	10.8x	→
3:	10.8x	→
4:	10.5	↑
5:	10.8x	↖
6:	10.3	←
7:	10.0	↖
8:	10.1	→
9:	10.2	↖
10:	10.4	↖
<b>Serie</b>		<b>100.0</b>
<b>Total</b>		<b>100.0</b>

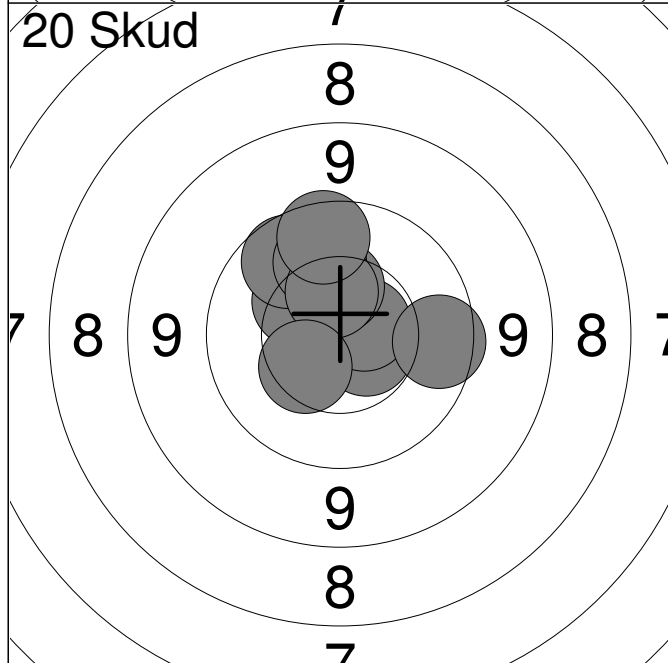

11:	10.3	↖
12:	10.6x	↘
13:	10.6x	↗
14:	9.8	→
15:	9.9	↖
16:	10.4	↑
17:	10.1	↑
18:	10.4	↑
19:	10.4	↖
20:	9.8	↑
<b>Serie</b>		<b>97.0</b>
<b>Total</b>		<b>197.0</b>

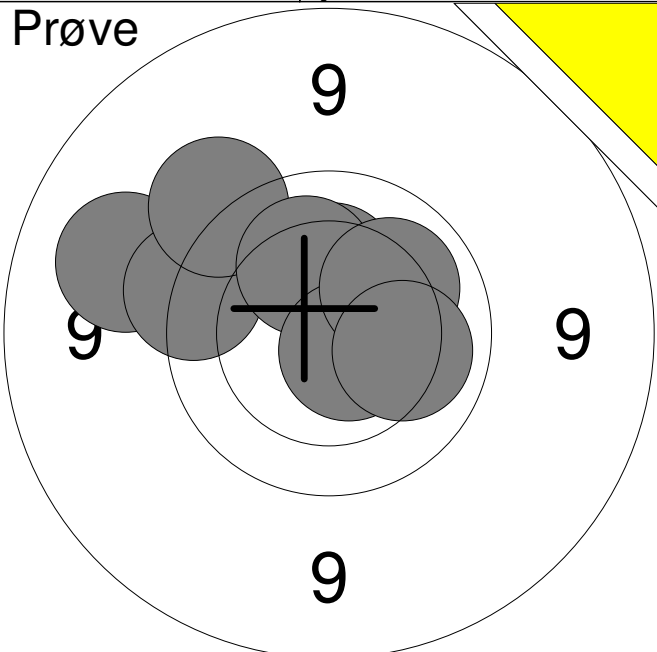
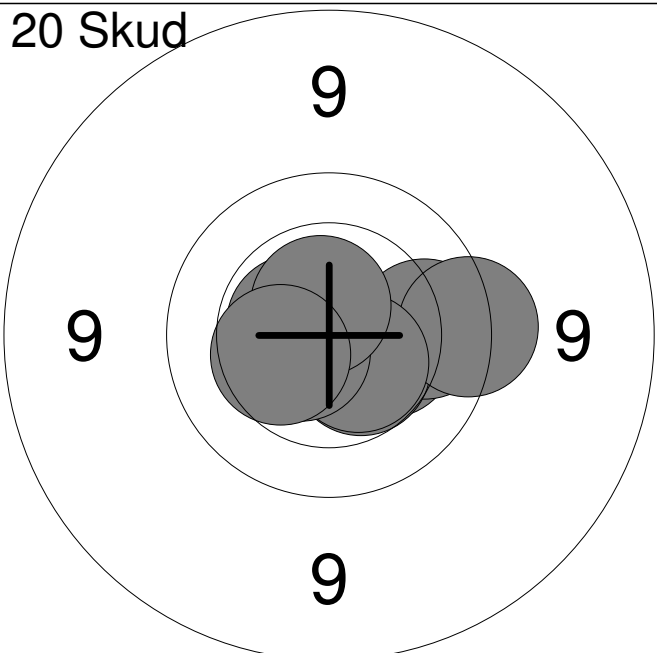
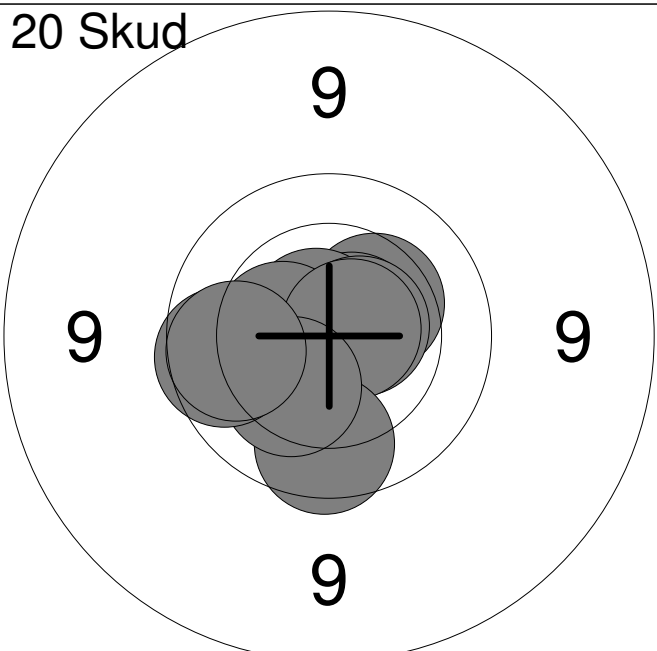
Hold	Skive		
8	5	Lea Larsen	
AAS		Vester Han Herred Skytteforenin	BK2
		Jyllandsstævne 2016	Aalborg Skyttekreds
<b>Prøve</b> 	1:	10.3	↑
	2:	9.2	↖
	3:	9.6	↖
	4:	9.5	↗
	5:	10.5x	↑
	6:	10.3	↗
	7:	10.2	↑
	8:	10.7x	↘
	9:	10.1	↗
	10:	10.1	→
	Serie		97.0
Total		0.0	
<b>20 Skud</b> 	1:	10.3	→
	2:	9.9	→
	3:	10.5	↘
	4:	9.7	→
	5:	10.6x	↖
	6:	10.8x	↖
	7:	10.5x	↘
	8:	10.6x	↖
	9:	10.6x	↑
	10:	10.4	↖
	Serie		98.0
Total		98.0	
<b>20 Skud</b> 	11:	10.3	↗
	12:	10.7x	↗
	13:	10.7x	↖
	14:	10.6x	→
	15:	10.5	↖
	16:	10.7x	↗
	17:	9.9	↘
	18:	10.3	↘
	19:	9.9	↖
	20:	9.9	↖
	Serie		97.0
Total		195.0	

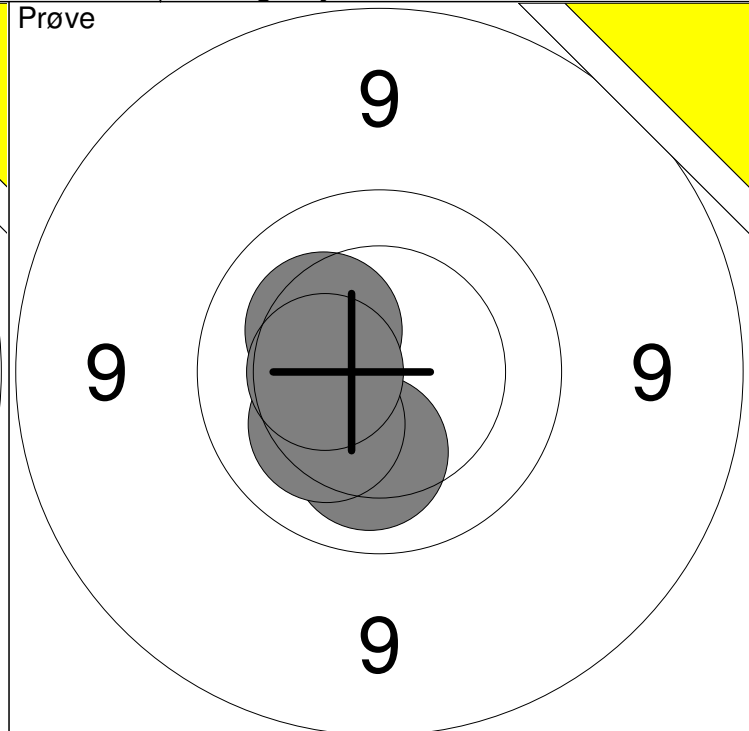
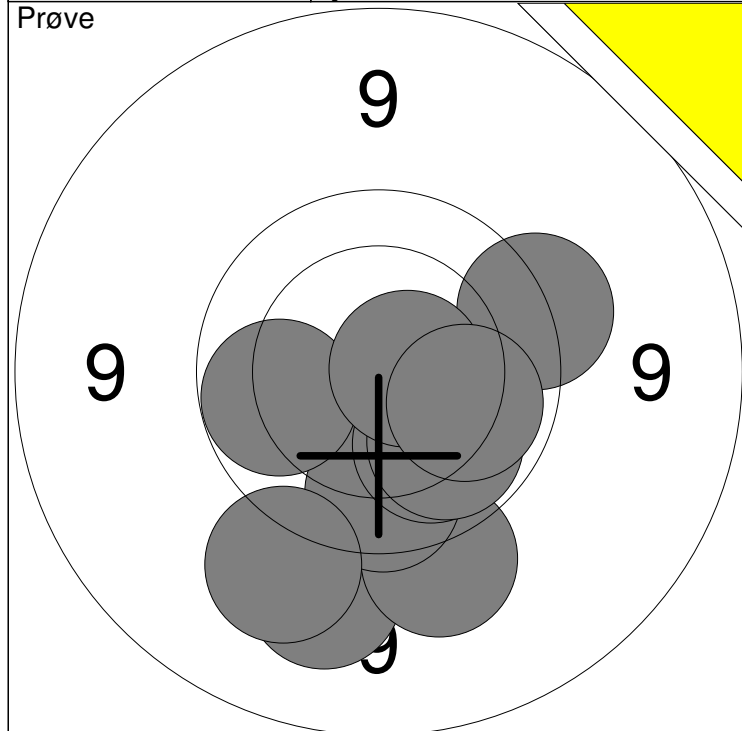

1: 9.6 →	6: 9.3 ↓	Serie	95
2: 9.3 ↓	7: 10.0 ↓		
3: 9.4 ↓	8: 10.0 ←	Total	0
4: 9.9 ↓	9: 10.7x →		
5: 10.1 ↓	10: 10.1 →		

11: 10.2 ↓	Serie	40
12: 10.3 ↗		
13: 10.2 ↙	Total	0
14: 10.4 ←		

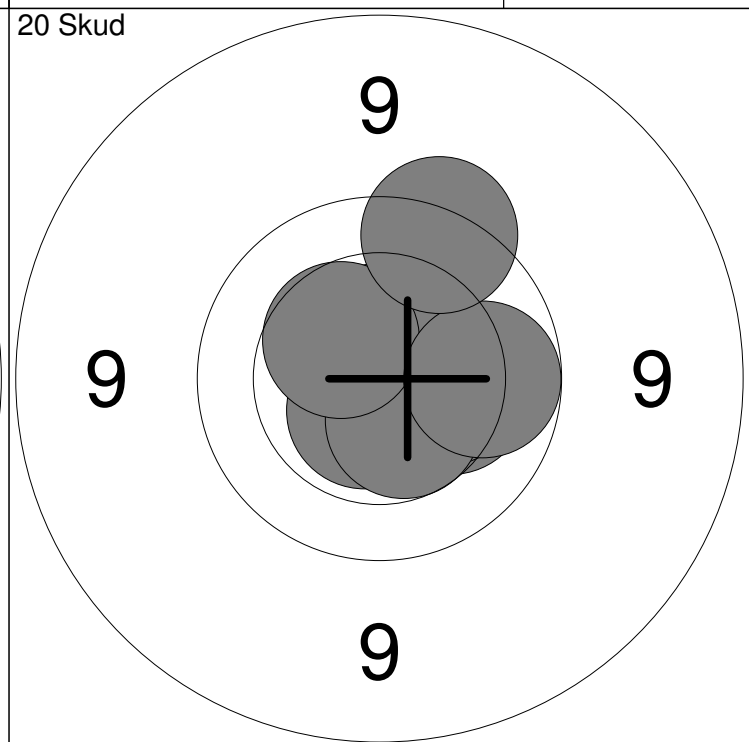
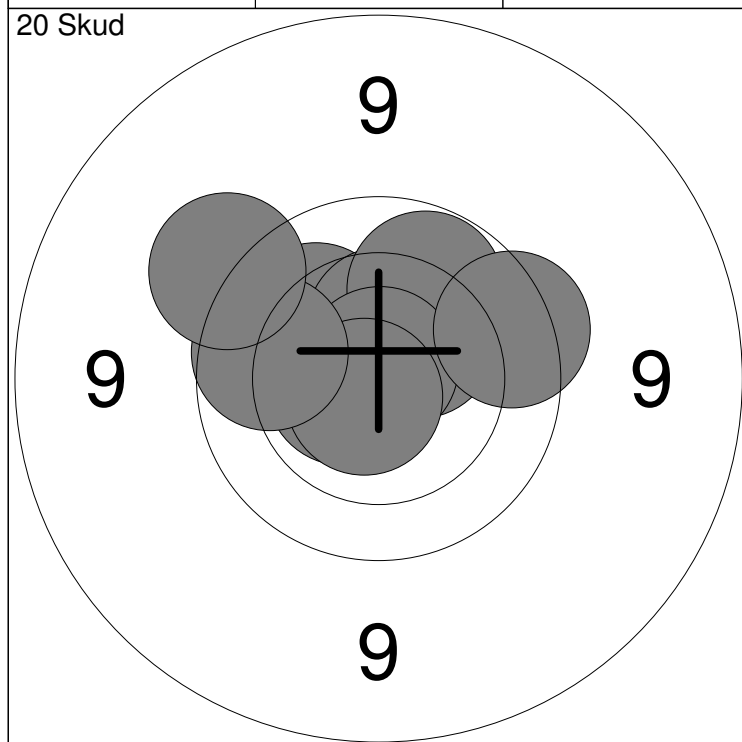

1: 10.1 ↖	6: 10.8x ↑	Serie	97
2: 10.4 ↑	7: 10.7x ↓		
3: 10.4 ↗	8: 9.7 →	Total	97
4: 10.0 ↗	9: 9.9 ←		
5: 10.6x ←	10: 9.5 ↖		

11: 10.2 →	16: 10.6x ↑	Serie	99
12: 10.6x ↑	17: 10.5 ↓		
13: 10.6x ↓	18: 10.4 ↖	Total	196
14: 10.3 →	19: 10.0 →		
15: 10.6x ↓	20: 9.7 ↗		

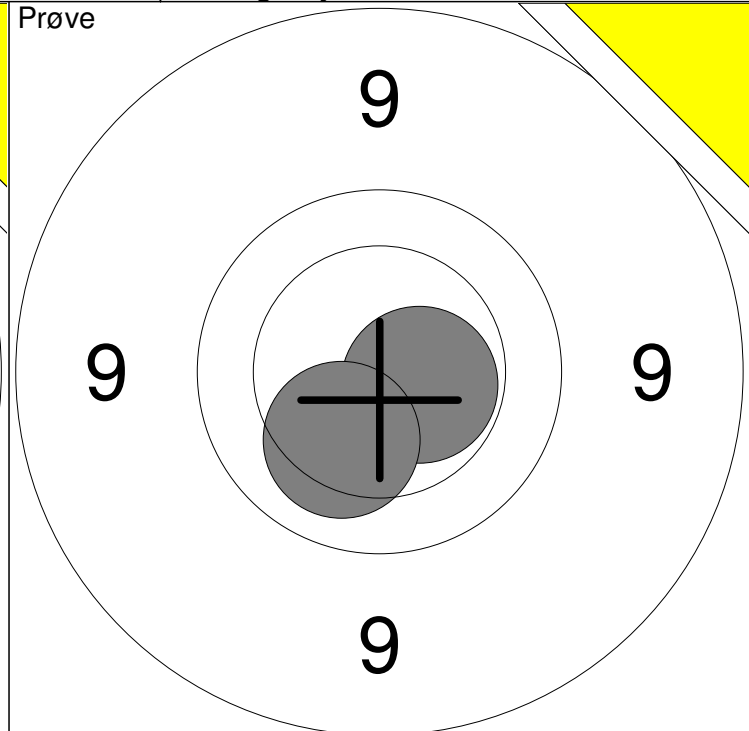
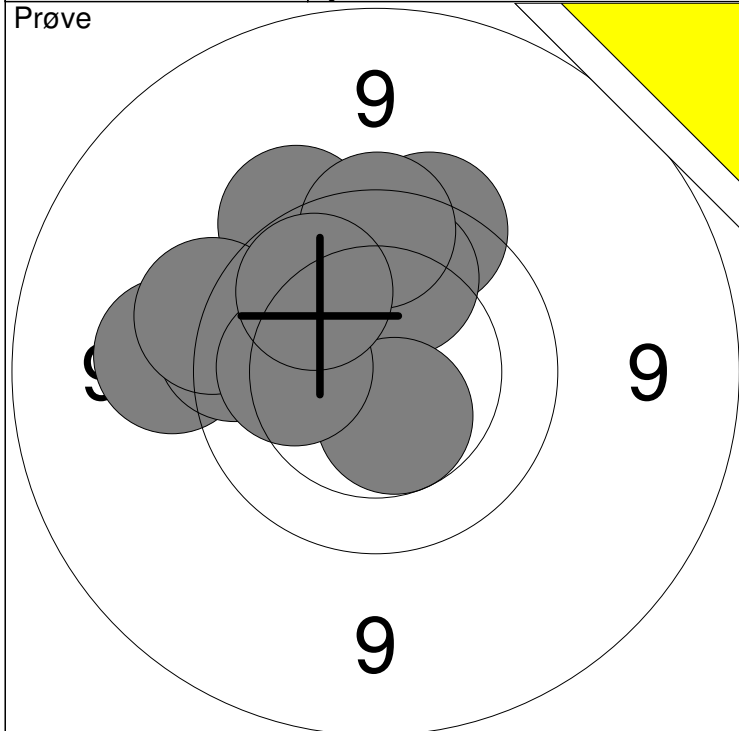

1: 9.4 ←	6: 9.7 ←	Serie	94
2: 9.7 ↗	7: 9.6 ↖		
3: 10.0 ↗	8: 10.5x ↘	Total	0
4: 9.6 ↖	9: 10.2 ←		
5: 9.7 ↗	10: 10.0 ↗		

11: 10.5x →	Serie	20
12: 10.2 ↘		
Total		0

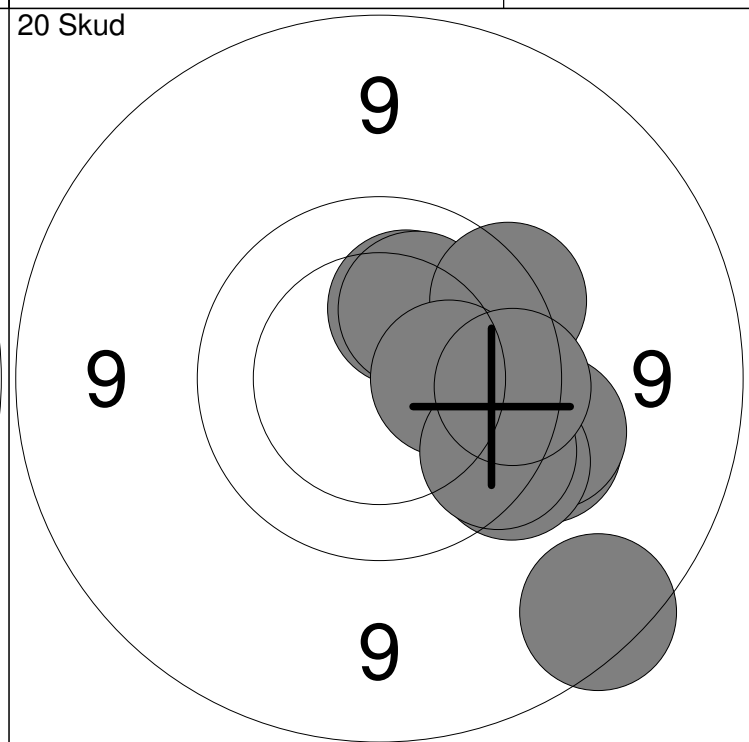
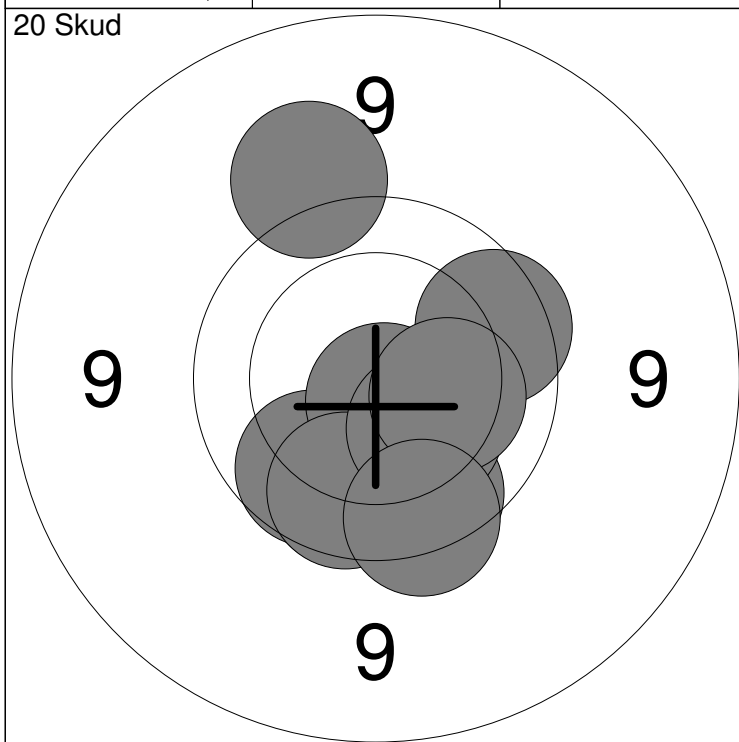

1: 9.9 ↘	6: 9.8 →	Serie	93
2: 9.9 ↘	7: 9.4 ↗		
3: 9.8 ↘	8: 10.3 ↘	Total	93
4: 10.7x ↘	9: 10.2 →		
5: 9.9 ↘	10: 9.7 ↘		

11: 10.2 ↗	16: 9.7 ↗	Serie	92
12: 9.5 →	17: 10.3 →		
13: 9.5 →	18: 9.8 ↘	Total	185
14: 9.7 ↘	19: 9.8 →		
15: 10.2 ↗	20: 8.8 ↘		

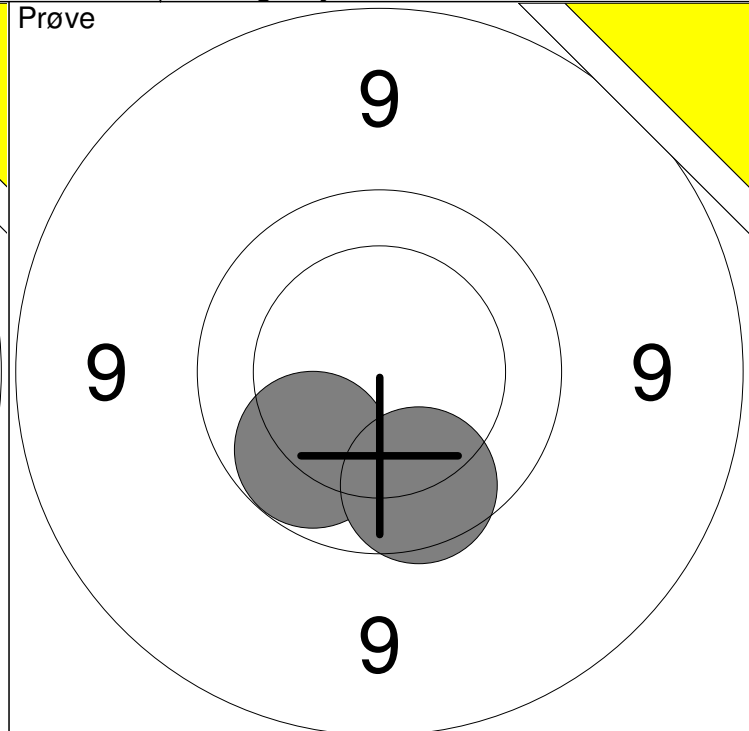
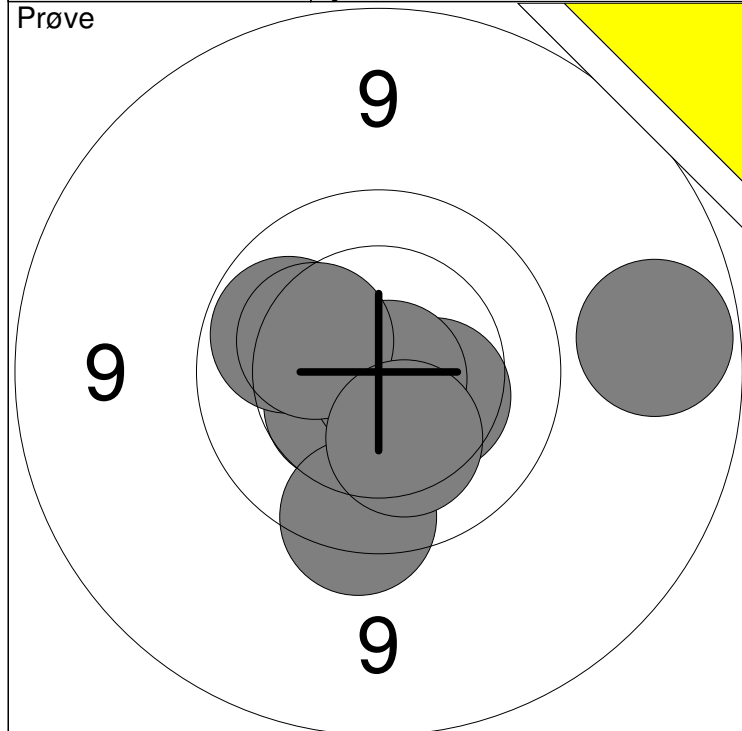

1: 10.4 ←	6: 10.8x ↘	Serie	98
2: 10.5 ↙	7: 10.3 ↗		
3: 10.4 ↘	8: 9.7 ↘	Total	0
4: 10.4 ↘	9: 10.3 ↘		
5: 10.0 ←	10: 9.0 →		

11: 10.0 ↙	Serie	19
12: 9.9 ↘		
	Total	0

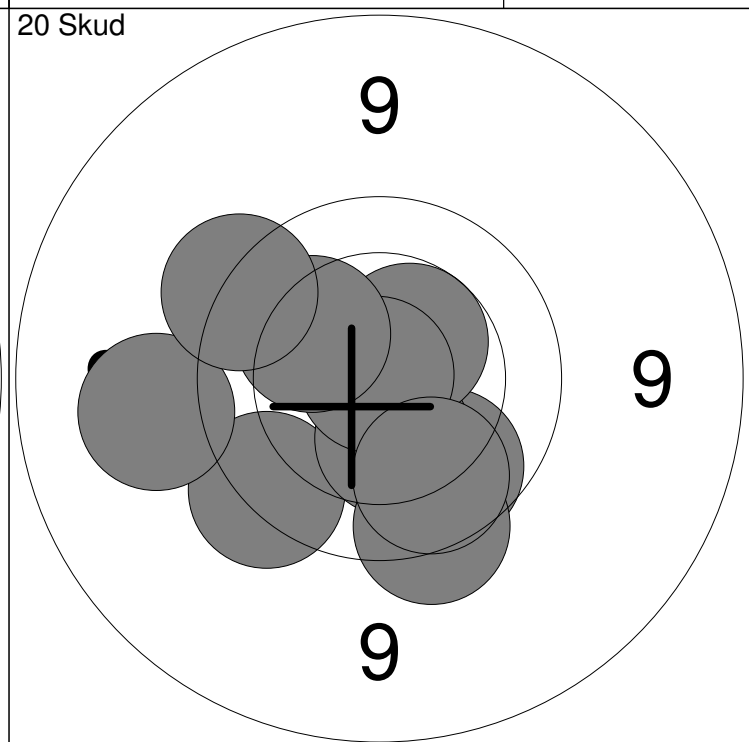
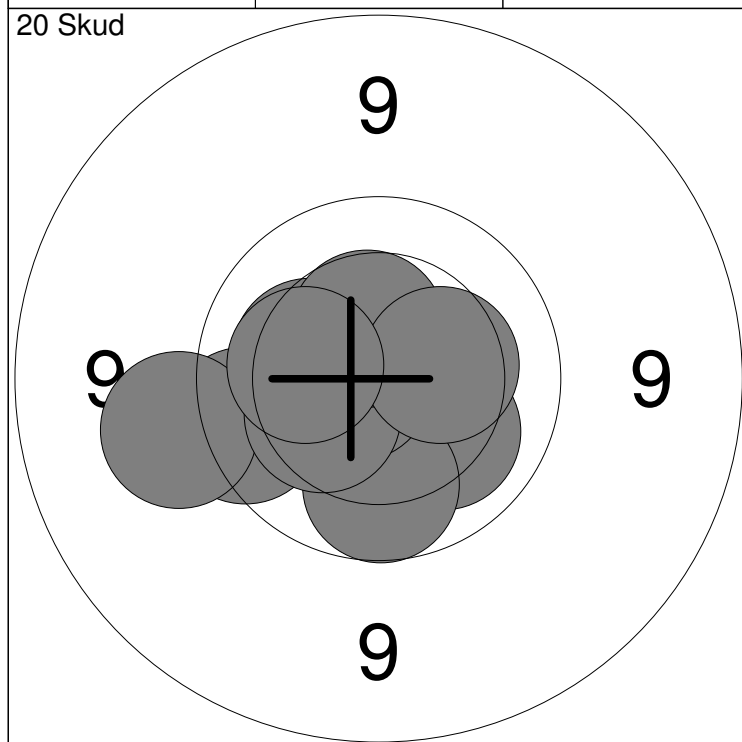

1: 9.7 ←	6: 10.7x ←	Serie	97
2: 9.4 ←	7: 10.3 ↙		
3: 10.3 ←	8: 10.5 ↑	Total	97
4: 10.1 ↘	9: 10.3 →		
5: 9.9 ↓	10: 10.2 ←		

11: 9.6 ↙	16: 10.5 ↗	Serie	94
12: 9.9 ↘	17: 10.9x ↗		
13: 10.4 ↘	18: 9.9 ↘	Total	191
14: 9.7 ↘	19: 10.2 ↗		
15: 9.3 ←	20: 9.6 ↗		



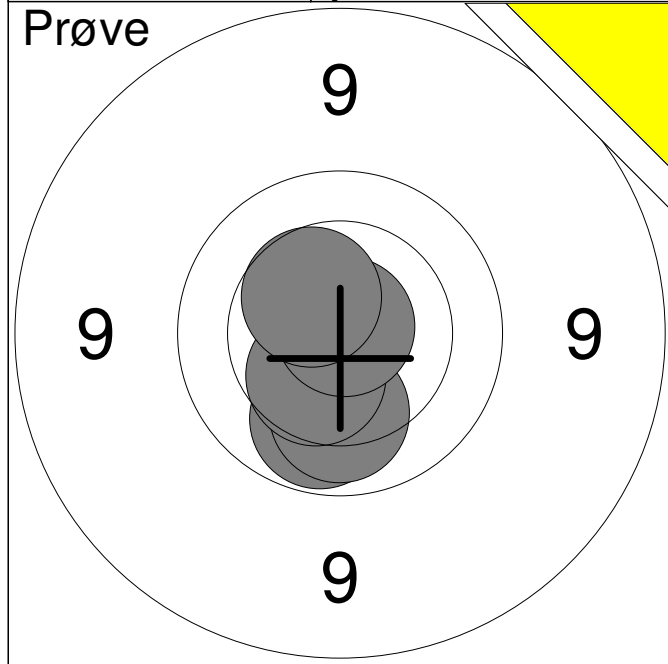

1:	10.6x	↙
2:	10.0	↙
3:	10.1	↘
4:	10.4	↙
5:	10.9x	↗
6:	10.5	↗
<b>Serie</b>		<b>60.0</b>
<b>Total</b>		<b>0.0</b>

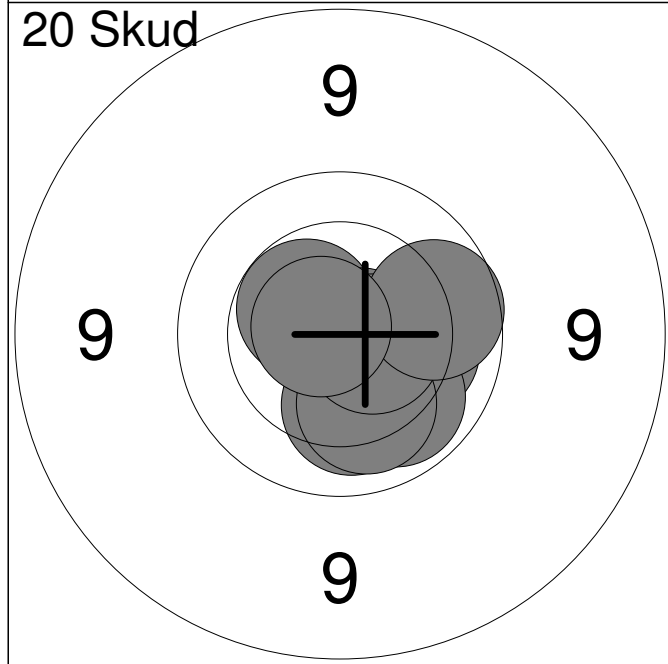

1:	10.5x	↗
2:	10.4	↘
3:	10.2	→
4:	10.7x	→
5:	10.2	↘
6:	10.1	↘
7:	10.2	↘
8:	10.6x	→
9:	9.9	→
10:	10.7x	↖
<b>Serie</b>		<b>99.0</b>
<b>Total</b>		<b>99.0</b>

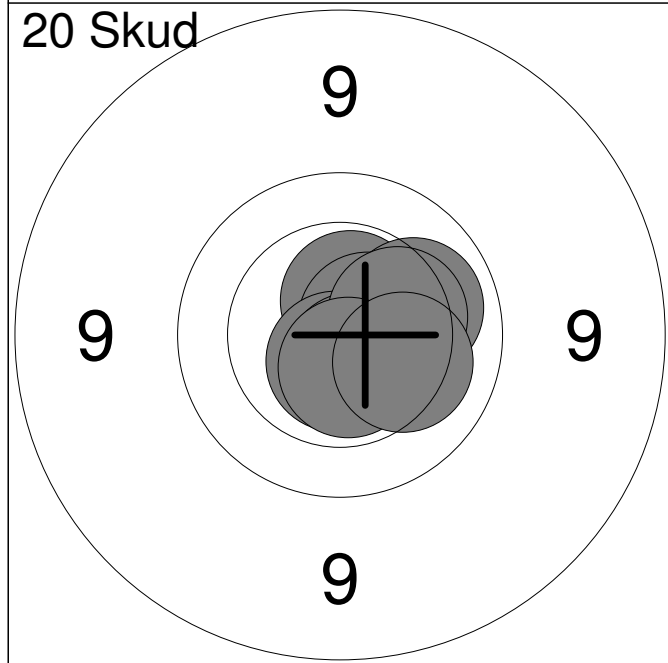

11:	10.6x	↖
12:	10.3	→
13:	10.6x	↗
14:	10.3	→
15:	10.7x	↘
16:	10.1	↗
17:	10.6x	↘
18:	10.3	→
19:	10.6x	↘
20:	10.2	↘
<b>Serie</b>		<b>100.0</b>
<b>Total</b>		<b>199.0</b>

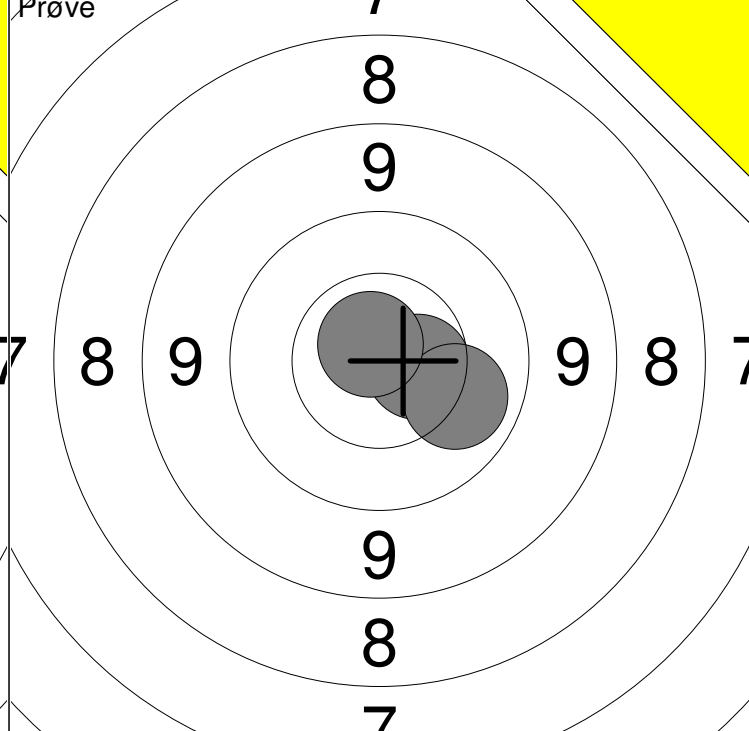
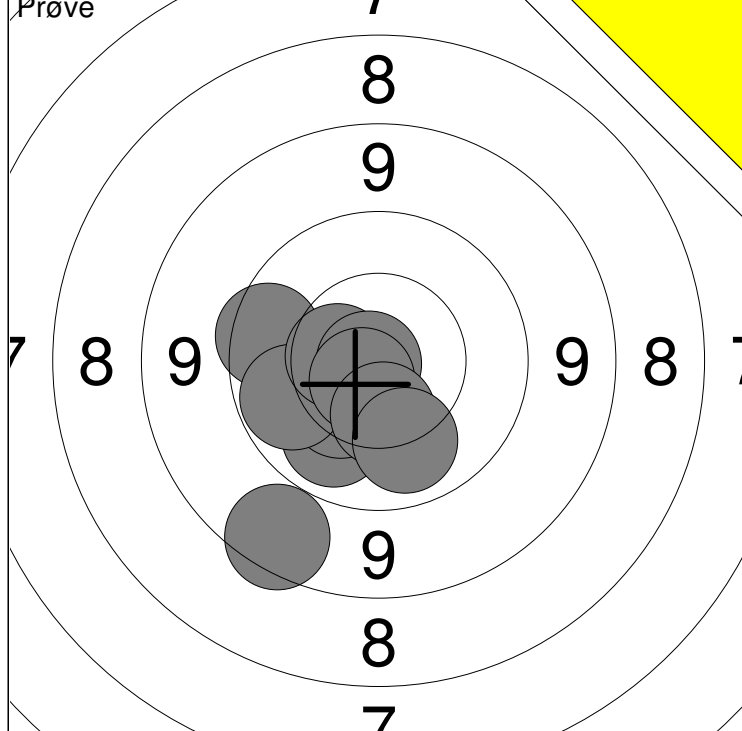

1: 8.7 ↘	6: 10.5 ←	Serie	97
2: 10.1 ↘	7: 10.8x ←		
3: 10.3 ↘	8: 10.7x ↘	Total	0
4: 9.8 ←	9: 10.4 ↓		
5: 10.0 ←	10: 10.1 ↓		

11: 10.5 →	Serie	30
12: 10.1 ↘		
13: 10.8x ↗	Total	0

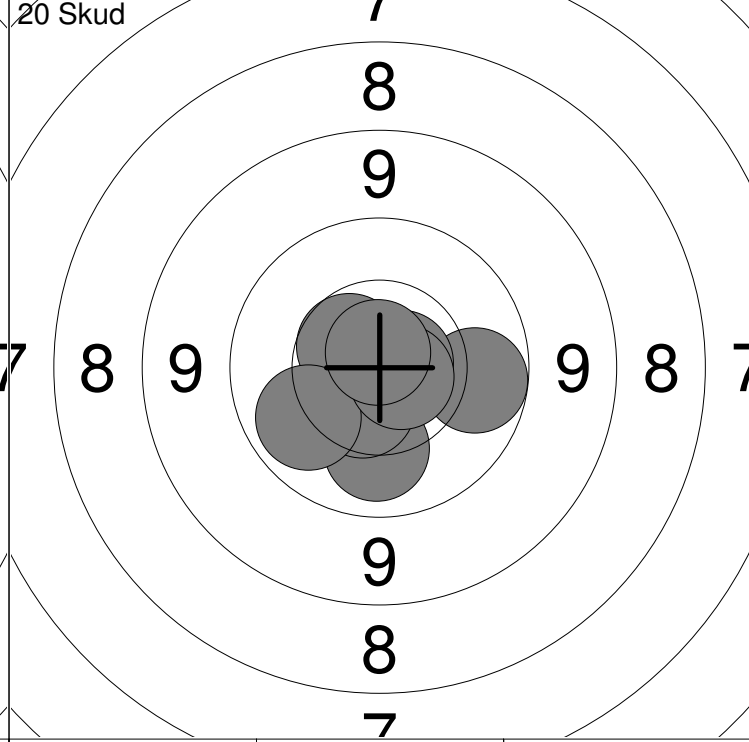
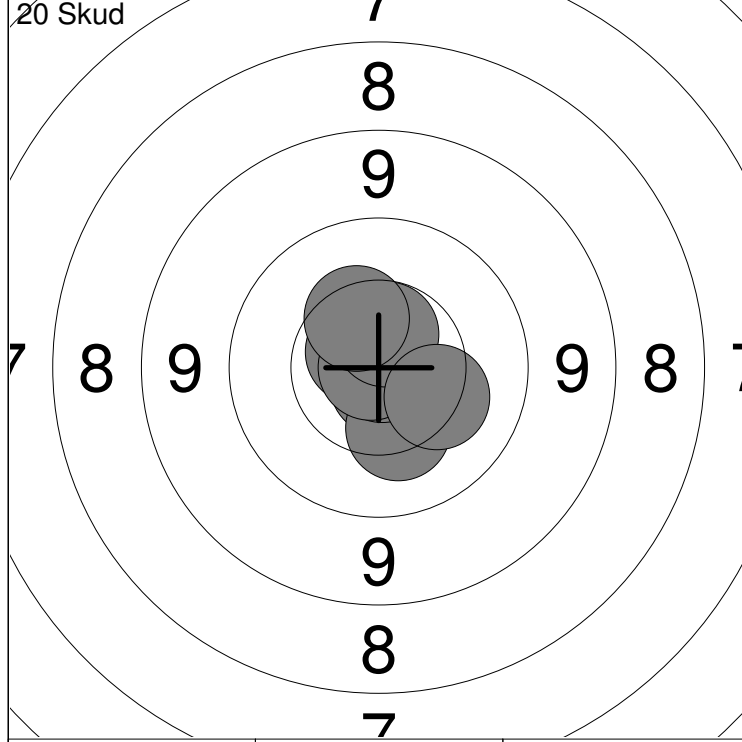

1: 10.9x ↑	6: 10.9x ↘	Serie	100
2: 10.8x ↓	7: 10.9x ←		
3: 10.5 ↓	8: 10.6x ↑	Total	100
4: 10.3 ↓	9: 10.4 ↗		
5: 10.7x ↗	10: 10.3 ↘		

11: 10.1 ↓	Serie	100
12: 10.8x ↘		
13: 10.0 →	Total	200
14: 10.7x →		
15: 10.7x ↙		

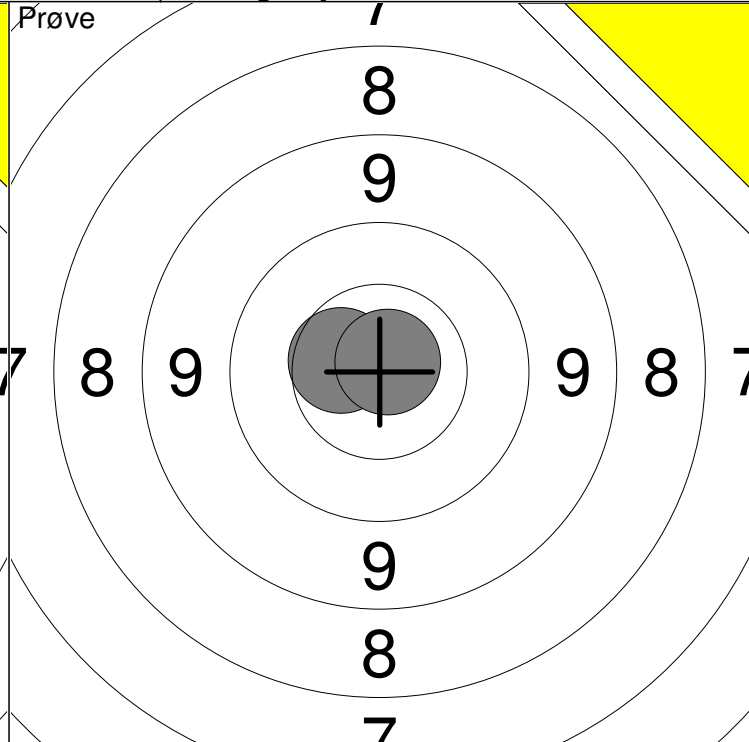
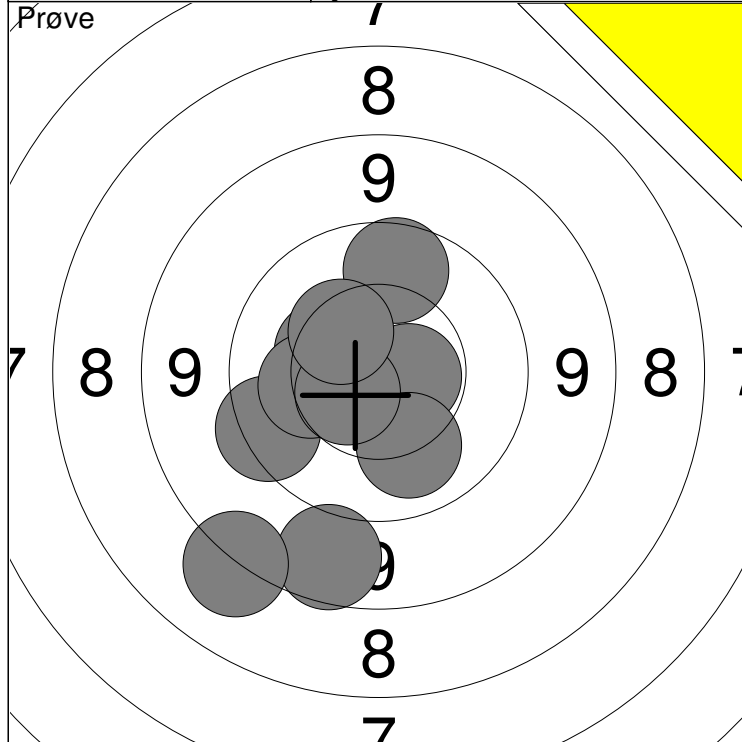

1: 8.9 ↓	6: 10.1 ↓	Serie	94
2: 8.3 ↘	7: 9.9 ↑		
3: 10.4 ↖	8: 10.2 ←	Total	0
4: 9.6 ↙	9: 10.6 ↙		
5: 10.6x →	10: 10.4 ↖		

11: 10.5 ←	Serie	20
12: 10.8x ↗		
Total		0

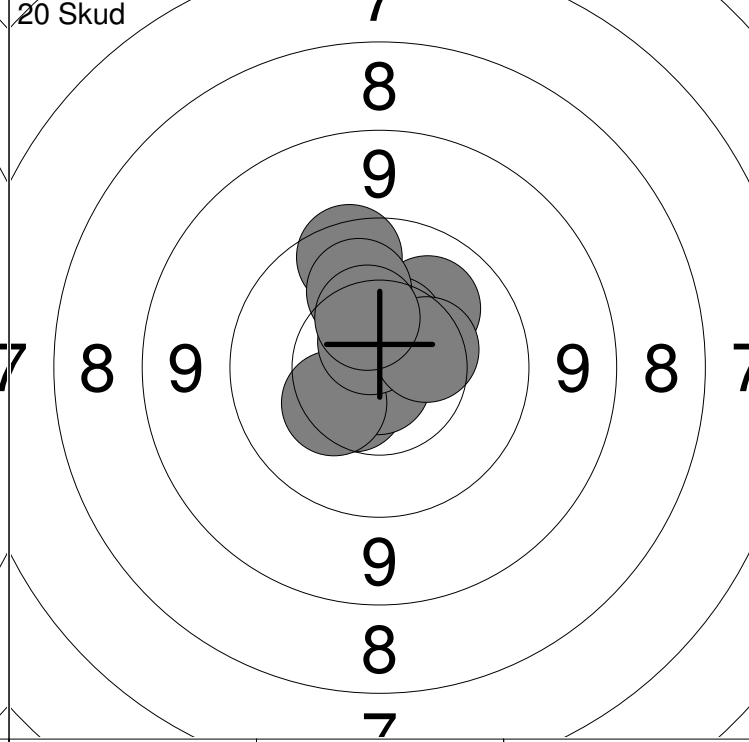
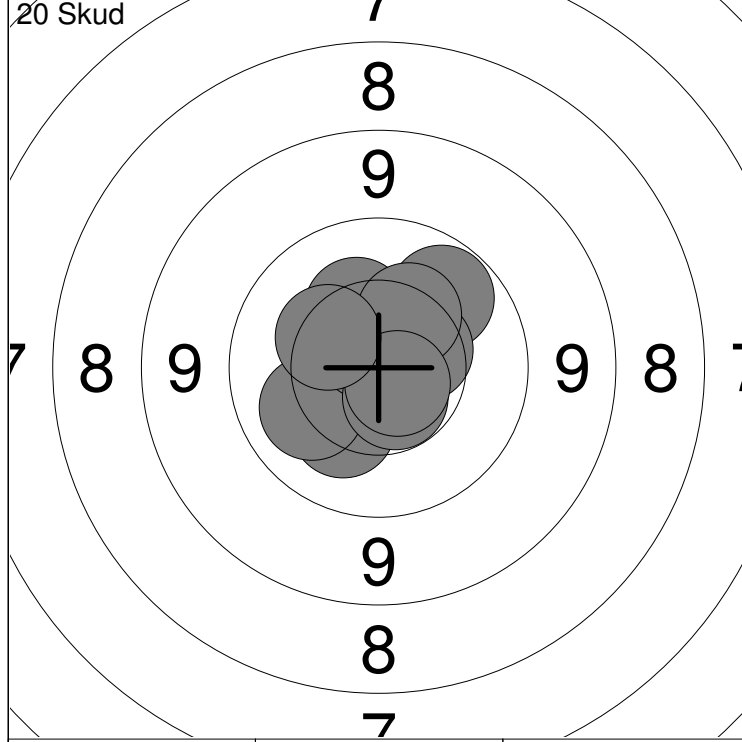

1: 10.3 ↘	6: 10.3 ↗	Serie	100
2: 10.1 ↙	7: 10.5 ↗		
3: 10.7x ↗	8: 10.3 ↗	Total	100
4: 10.0 ↗	9: 10.7x ↘		
5: 10.6x ↘	10: 10.3 ↖		

11: 10.2 ↗	Serie	99
12: 9.8 ↑		
13: 10.5 ↙	Total	199
14: 10.5 ↑		
15: 10.8x ↓	16: 10.4 ↙	
	17: 10.7x ↑	
	18: 10.1 ↑	
	19: 10.4 ↗	
	20: 10.4 ↑	

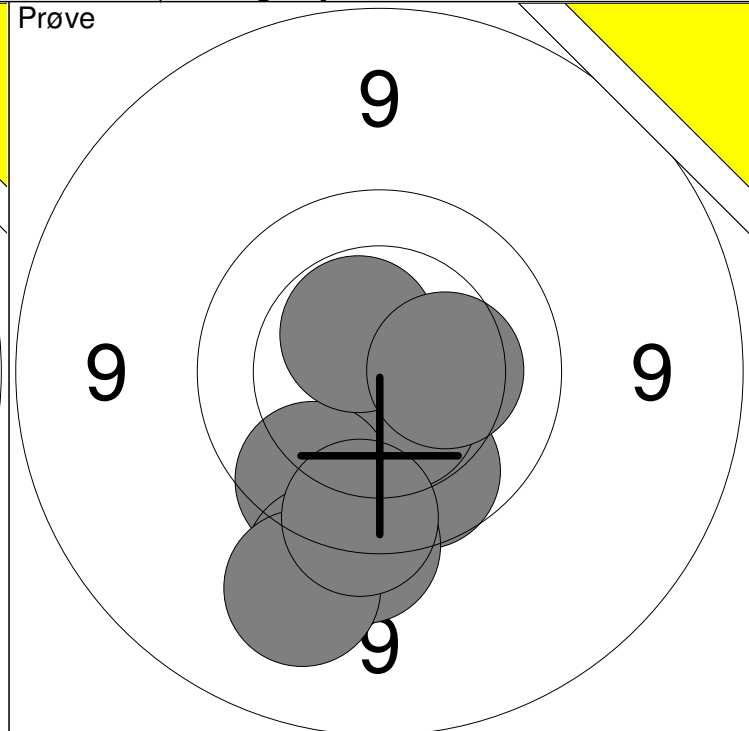
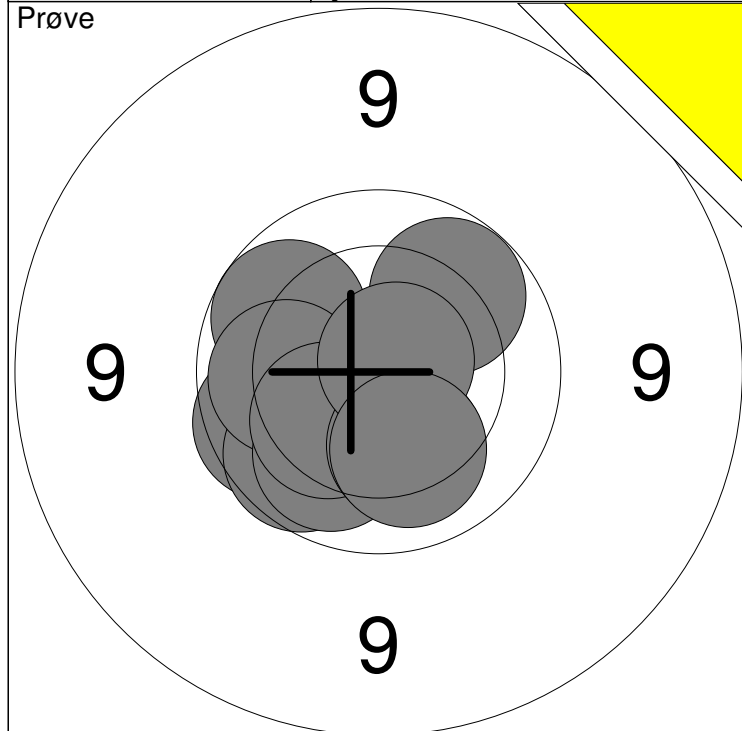

1: 10.0 ↗	6: 10.0 ↓	Serie	97
2: 9.9 ←	7: 10.3 ↓		
3: 9.9 ↓	8: 10.2 ↓	Total	0
4: 9.9 ↖	9: 10.7x ↗		
5: 10.1 ←	10: 10.2 ↓		

11: 9.9 ↓	16: 9.3 ↓	Serie	84
12: 10.5x ↓	17: 9.7 ↓		
13: 9.8 ↓	18: 10.5x ↗	Total	0
14: 9.4 ↓	19: 10.3 →		
15: 9.6 ↓			

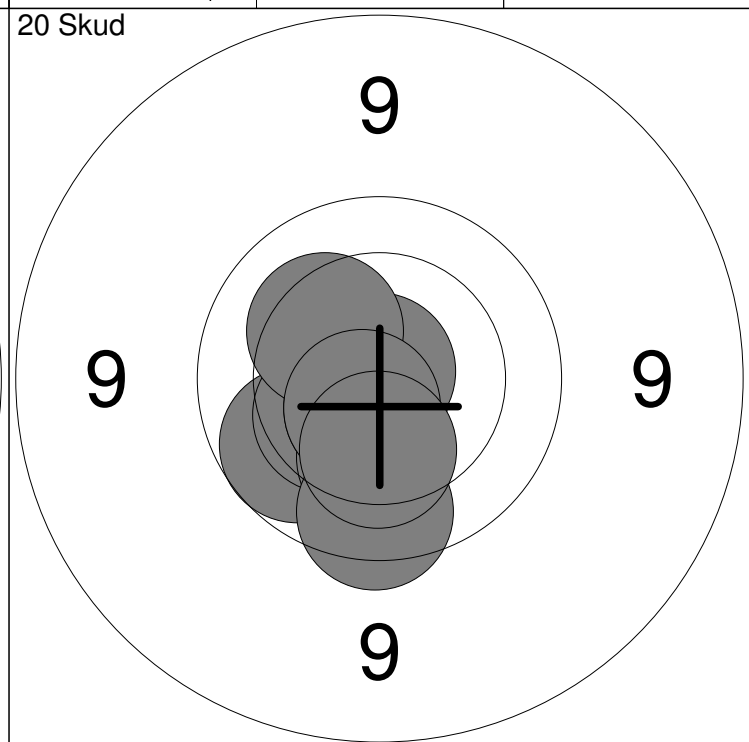
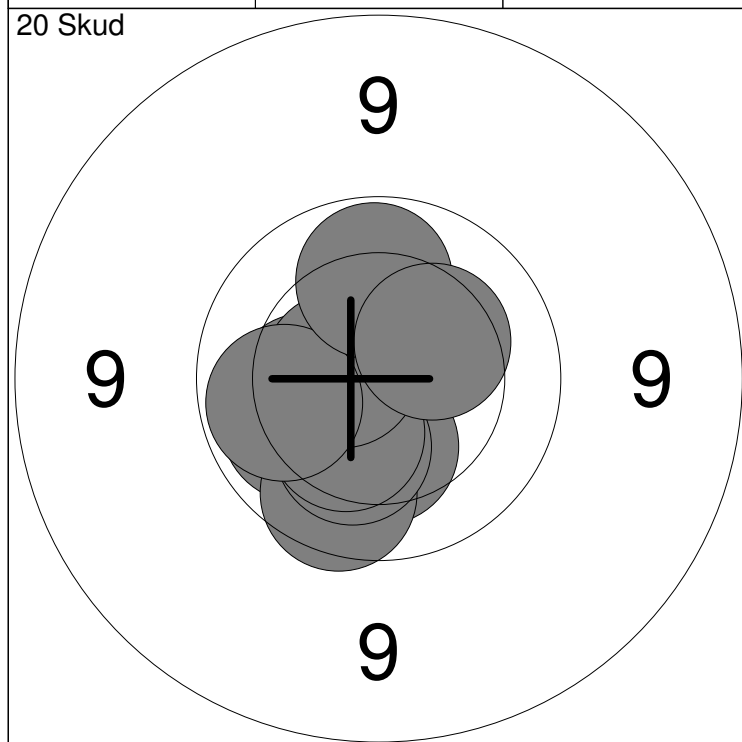

1: 10.1 ←	6: 10.3 ↓	Serie	99
2: 10.3 ↓	7: 10.6x ←		
3: 9.9 ↓	8: 10.0 ←	Total	99
4: 10.2 ↓	9: 10.0 ↑		
5: 10.2 ←	10: 10.3 ↗		

11: 9.9 ←	16: 10.9x ↑	Serie	98
12: 10.4 ←	17: 9.8 ↓		
13: 10.8x ↓	18: 10.3 ↖	Total	197
14: 10.6x ↓	19: 10.6x ↓		
15: 10.2 ↓	20: 10.3 ↓		

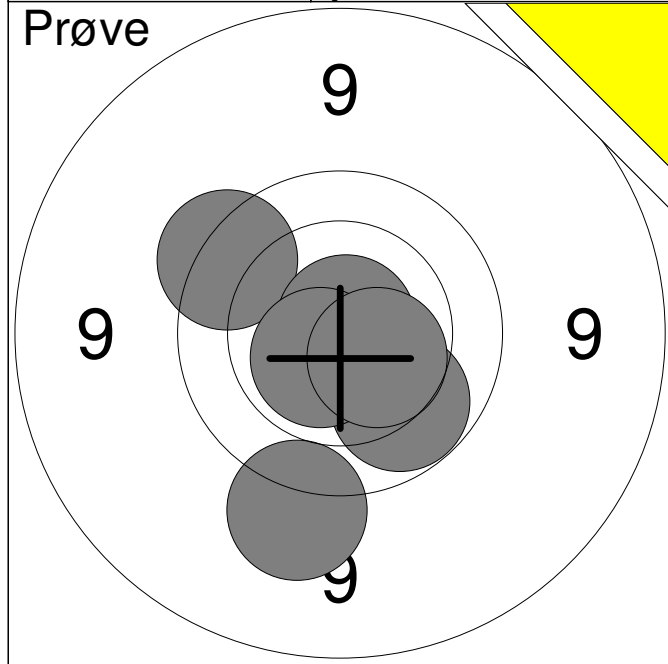

1:	9.7	↗
2:	9.4	↘
3:	10.0	↘
4:	10.8x	↗
5:	10.6x	↘
6:	10.5	↘
<b>Serie</b>		<b>58.0</b>
<b>Total</b>		<b>0.0</b>

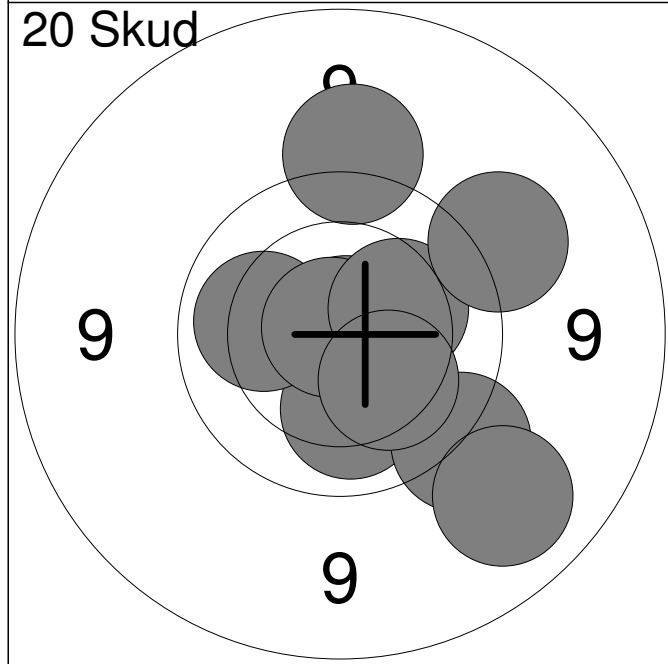

1:	10.1	↘
2:	10.8x	↗
3:	10.1	↖
4:	10.8x	↗
5:	10.3	↗
6:	9.5	↘
7:	9.4	↗
8:	9.4	↑
9:	10.2	↘
10:	9.1	↘
<b>Serie</b>		<b>96.0</b>
<b>Total</b>		<b>96.0</b>

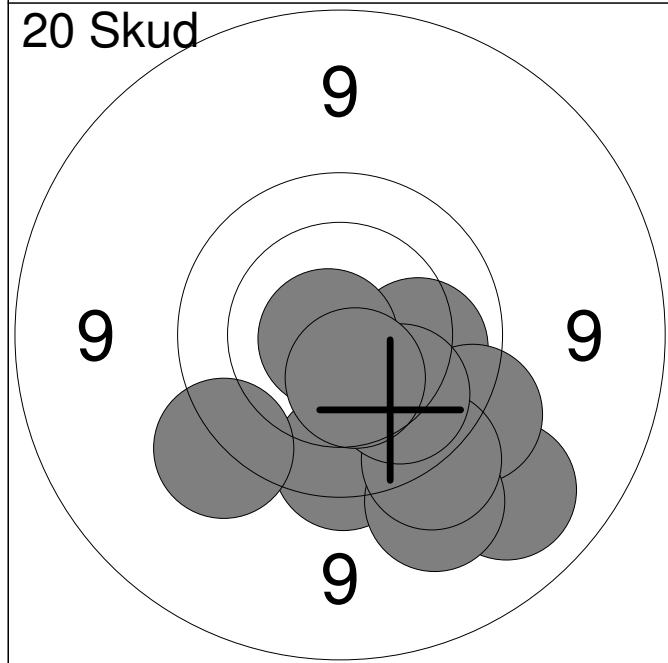

11:	10.1	→
12:	9.7	↘
13:	9.5	↖
14:	9.1	↘
15:	9.6	↘
16:	9.3	↘
17:	10.8x	↖
18:	9.6	↘
19:	10.0	↘
20:	10.5	↘
<b>Serie</b>		<b>94.0</b>
<b>Total</b>		<b>190.0</b>

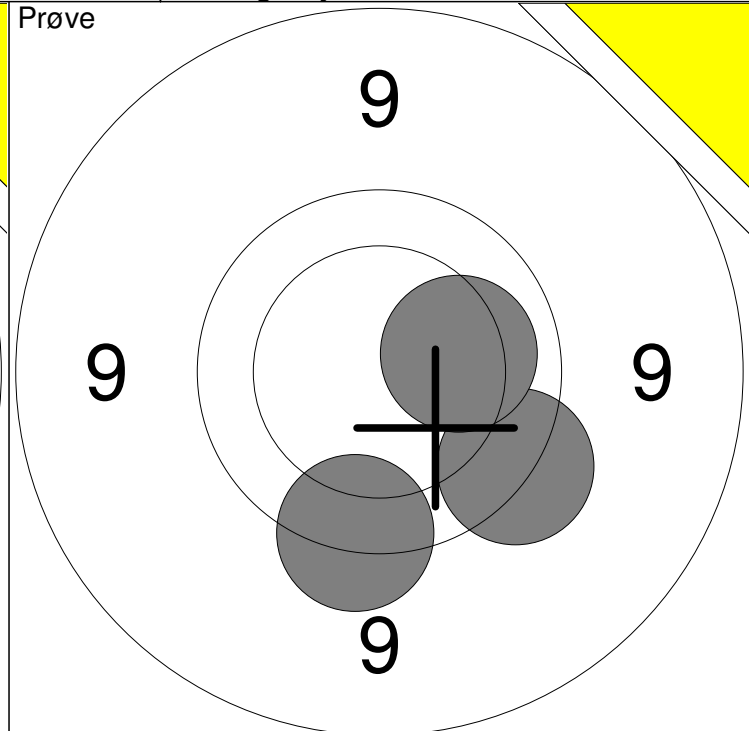
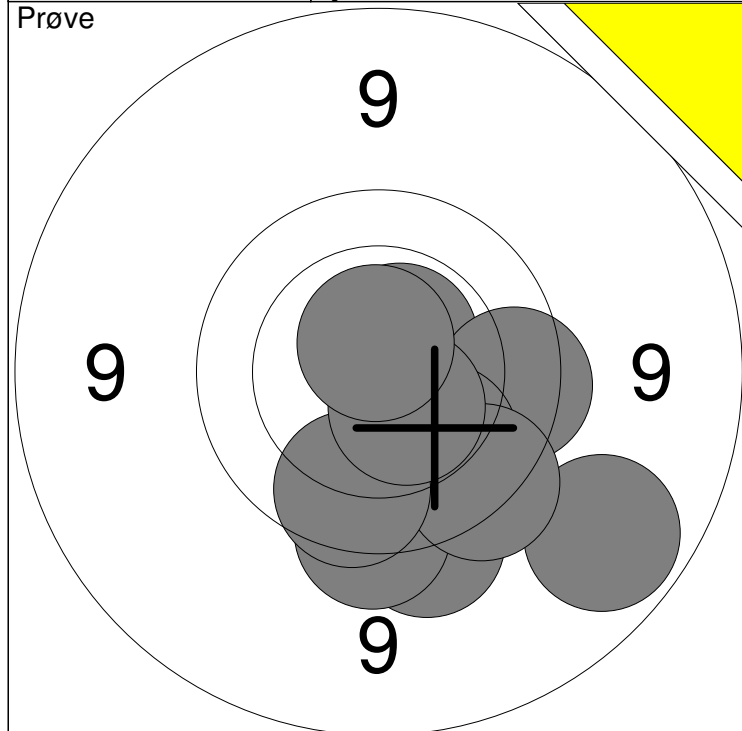

1: 10.6x ↗	6: 9.0 ↘	Serie	94
2: 9.6 ↓	7: 9.7 ↘		
3: 9.8 →	8: 9.9 ↘	Total	0
4: 9.6 ↓	9: 10.5x ↘		
5: 10.1 ↘	10: 10.7x ↑		

11: 9.6 ↓	Serie	28
12: 9.6 ↘		
13: 10.2 →	Total	0

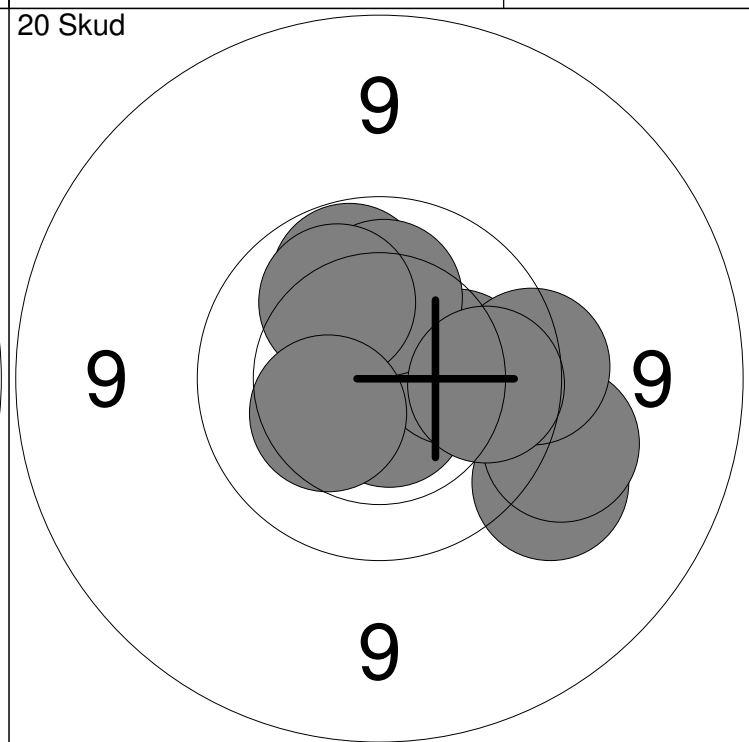
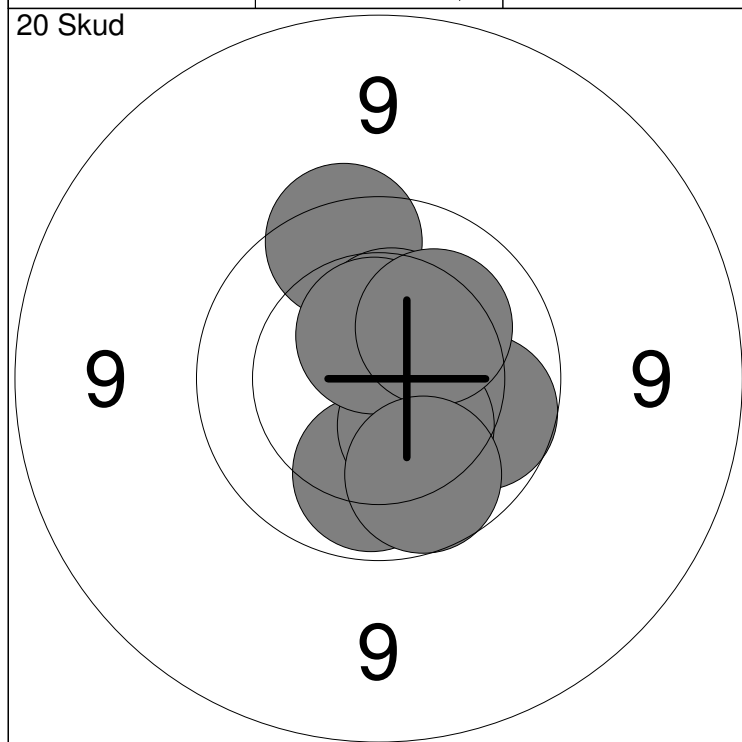

1: 10.2 →	6: 10.0 ↓	Serie	97
2: 10.2 ↘	7: 10.4 ↘		
3: 9.7 ↑	8: 10.5x ↑	Total	97
4: 10.4 ↑	9: 10.2 ↗		
5: 9.9 ↘	10: 9.9 ↘		

11: 10.6x ↓	16: 10.1 ↗	Serie	96
12: 10.0 ↑	17: 9.5 →		
13: 9.4 ↘	18: 9.7 →	Total	193
14: 10.2 →	19: 10.3 ↙		
15: 10.2 ↑	20: 9.9 →		

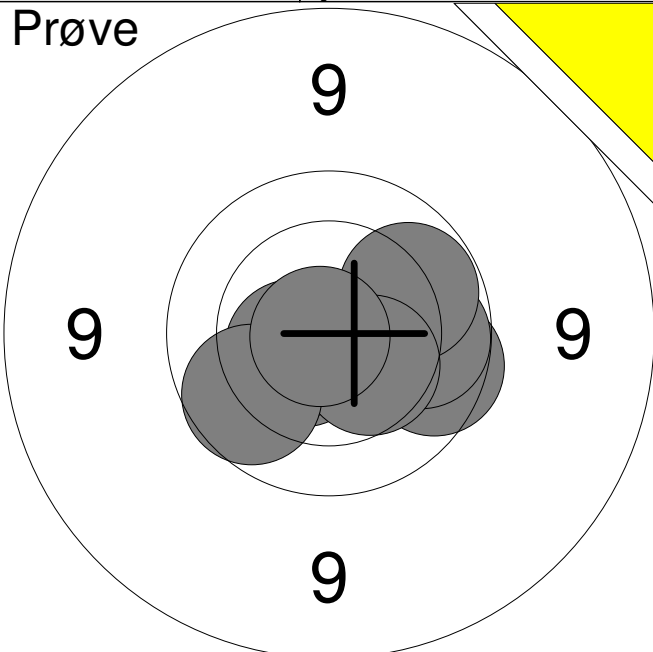
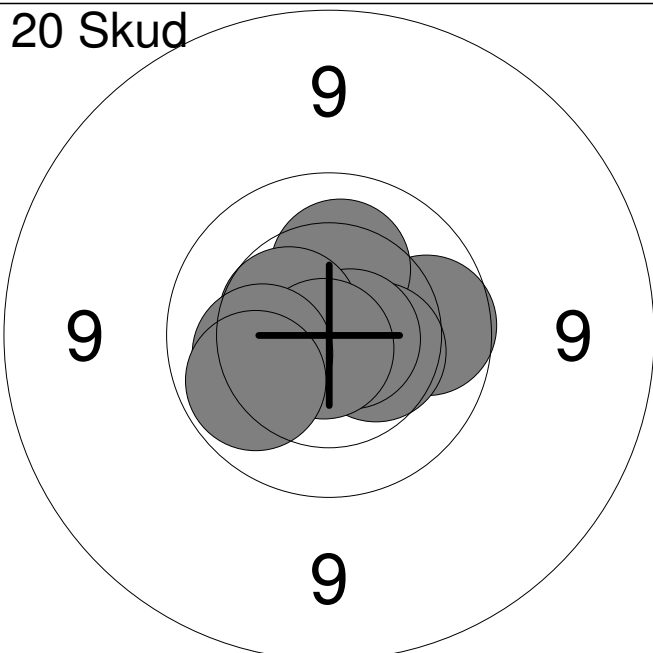
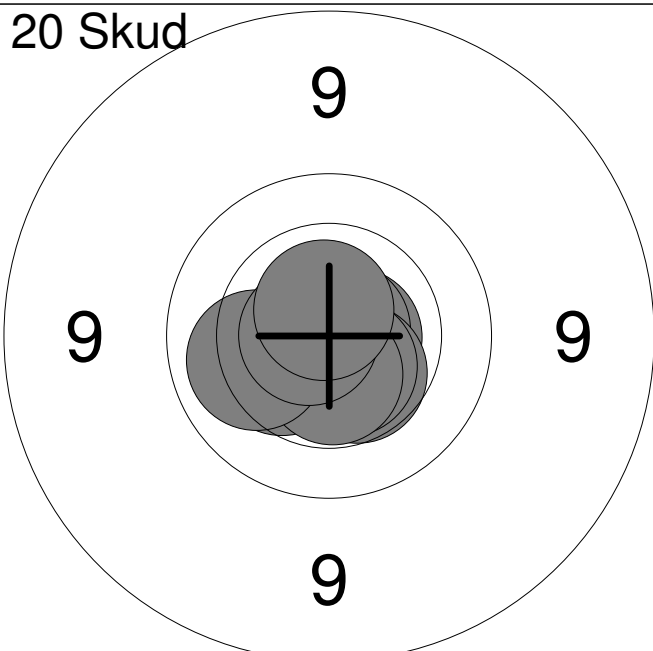
Hold	Skive	Anders Hansen	
9	4		
AAS	Aalborg Skyttekreds		MVÅ1
Jyllandsstævne 2016		Aalborg Skyttekreds	
Prøve		1: 10.1 → 2: 9.8 → 3: 10.0 → 4: 10.6x ↙ 5: 10.5x ↙ 6: 10.0 → 7: 10.4 ↘ 8: 9.9 ↙ 9: 10.8x ↙	
		Serie	88.0
		Total	0.0
20 Skud		1: 9.9 → 2: 10.7x ↑ 3: 10.2 ↑ 4: 10.4 → 5: 10.7x → 6: 10.2 ↙ 7: 10.5 ↗ 8: 10.8x ↘ 9: 10.2 ↙ 10: 10.0 ↙	
		Serie	99.0
		Total	99.0
20 Skud		11: 10.7x → 12: 10.8x → 13: 10.3 ↙ 14: 10.5 ↘ 15: 10.6x ↘ 16: 10.7x ↙ 17: 10.5x ↘ 18: 10.1 ↙ 19: 10.7x ↙ 20: 10.7x ↑	
		Serie	100.0
		Total	199.0

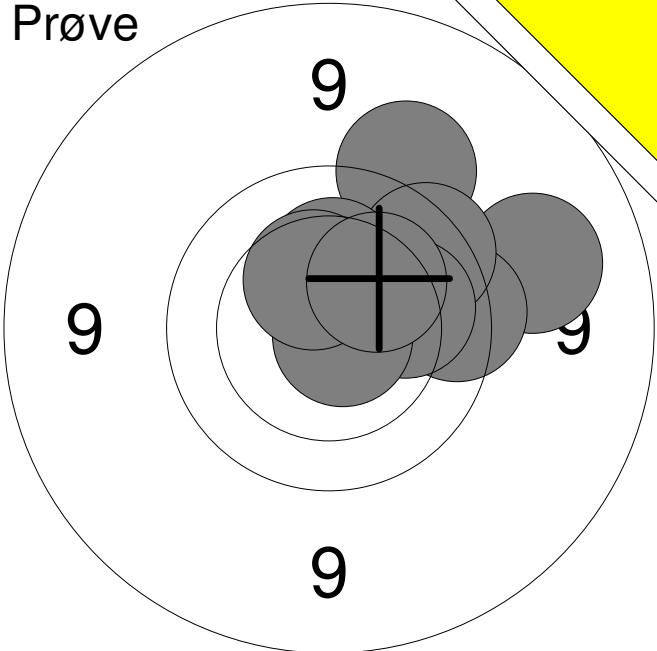
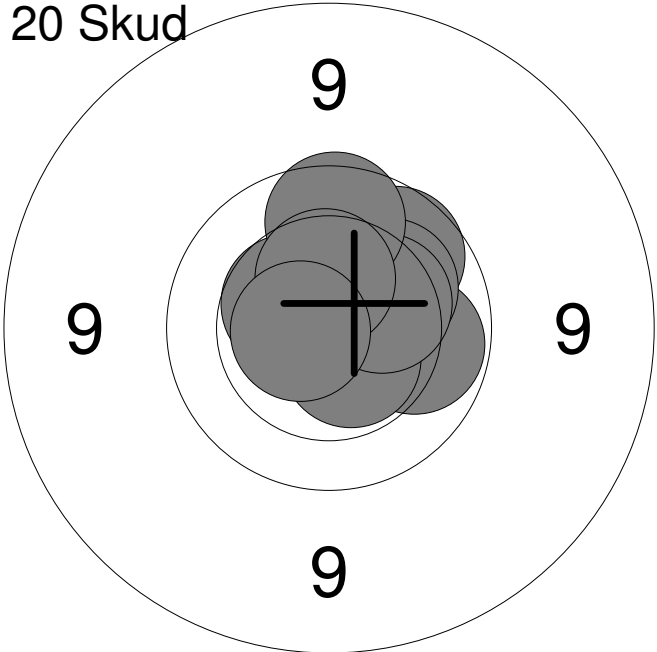
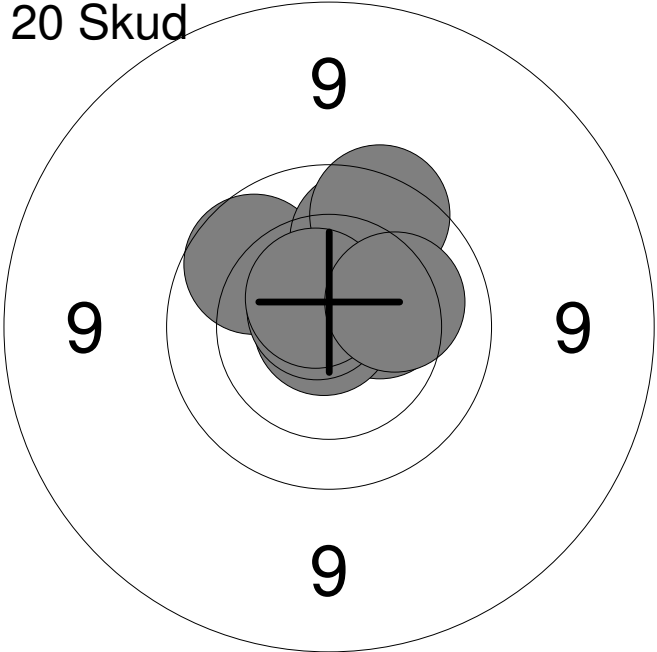
Hold	Skive	Johnni Hald	
9	6	AAS	Hobro Egnens Skytteforening
		Jyllandsstævne 2016	VÅ2
		Aalborg Skyttekreds	
Prøve		1: 9.8 →	→
		2: 9.2 →	→
		3: 9.4 ↗	↗
		4: 9.7 →	→
		5: 9.8 ↗	↗
		6: 10.1 →	→
		7: 10.8x ↘	↘
		8: 10.3 ↑	↑
		9: 10.4 ↗	↗
		10: 10.2 ↗	↗
		Serie	95.0
		Total	0.0
20 Skud		1: 9.9 ↗	↗
		2: 10.5 ↗	↗
		3: 10.0 →	→
		4: 10.6x ↘	↘
		5: 10.5 ↗	↗
		6: 10.2 ↗	↗
		7: 10.3 →	→
		8: 9.9 ↑	↑
		9: 10.4 ↑	↑
		10: 10.6x ←	←
		Serie	98.0
		Total	98.0
20 Skud		11: 9.9 ↖	↖
		12: 10.5x ↑	↑
		13: 10.4 →	→
		14: 10.2 ↗	↗
		15: 10.0 ↑	↑
		16: 10.9x ↖	↖
		17: 9.8 ↑	↑
		18: 10.7x ↗	↗
		19: 10.6x ↗	↗
		20: 10.2 →	→
		Serie	98.0
		Total	196.0



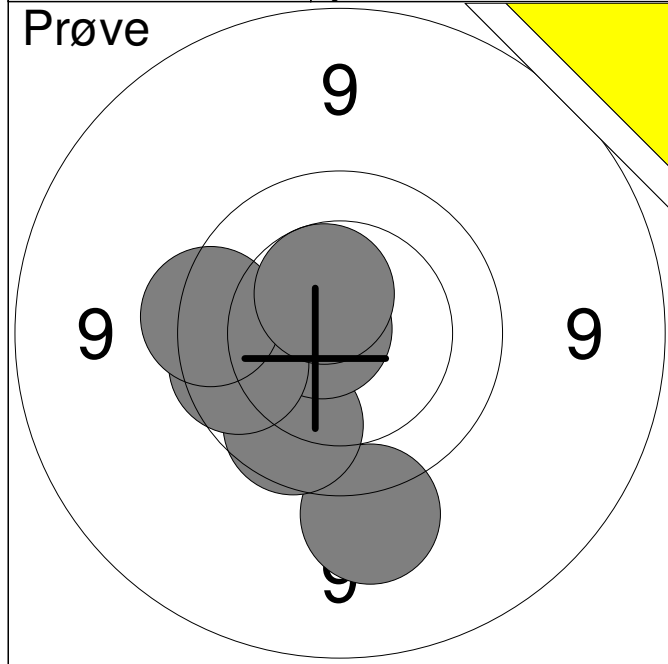

1:	9.4	↓
2:	9.9	↙
3:	10.7x	←
4:	9.9	↙
5:	9.7	←
6:	10.5x	↗

Serie	56.0
Total	0.0

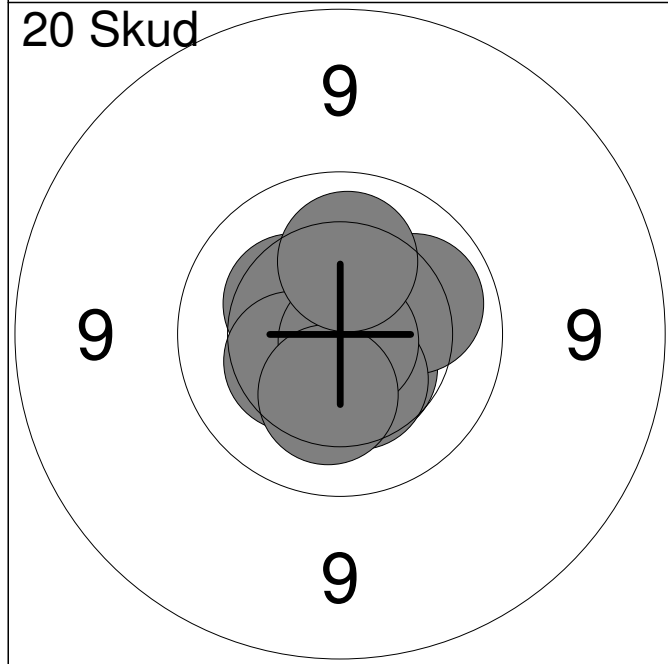

1:	10.5x	↙
2:	10.5	↓
3:	10.5x	↙
4:	10.1	↗
5:	10.3	↗
6:	10.4	↙
7:	10.4	↓
8:	10.8x	↓
9:	10.3	↓
10:	10.2	↑

Serie	100.0
Total	100.0

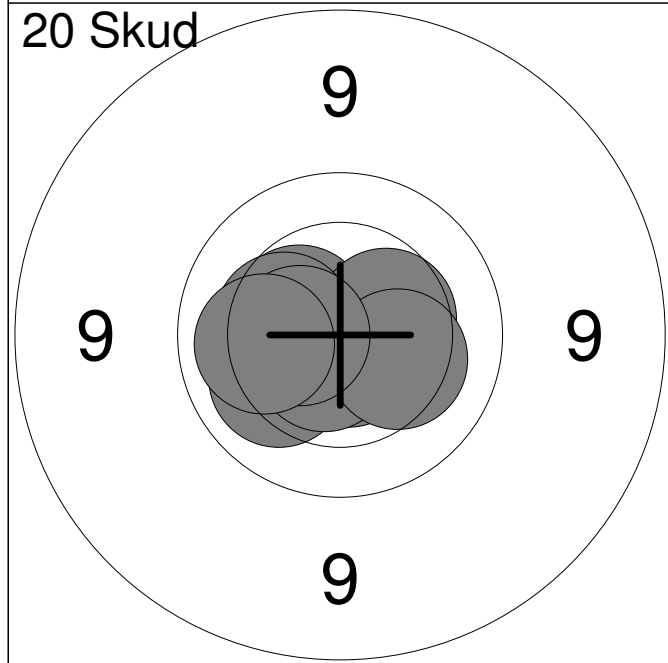

11:	10.5	↖
12:	10.1	↙
13:	10.5x	←
14:	10.7x	↓
15:	10.4	↗
16:	10.3	←
17:	10.6x	↙
18:	10.3	↗
19:	10.5x	←
20:	10.1	←

Serie	100.0
Total	200.0

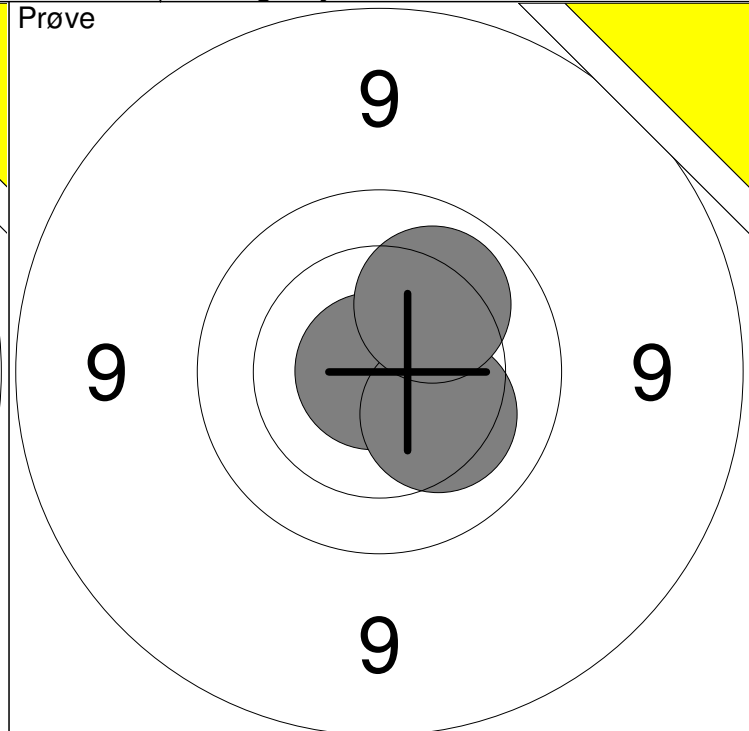
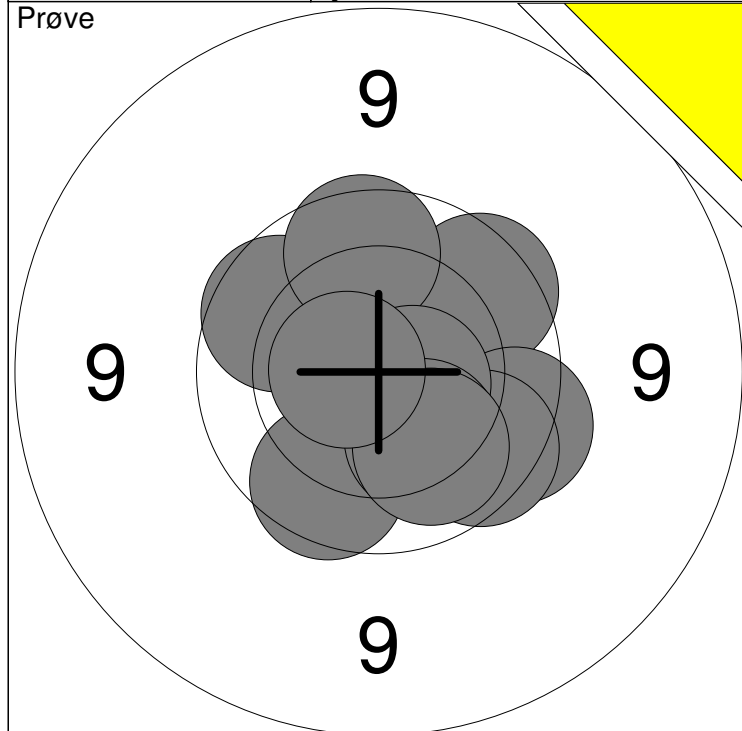

1: 9.9 ↖	6: 9.8 ↘	Serie	94
2: 9.9 ↙	7: 10.6x →		
3: 9.8 ↗	8: 10.2 ↘	Total	0
4: 9.9 ↑	9: 10.1 ↘		
5: 9.7 →	10: 10.6x ←		

11: 10.9x ←	Serie	30
12: 10.3 ↘		
13: 10.1 ↗	Total	0

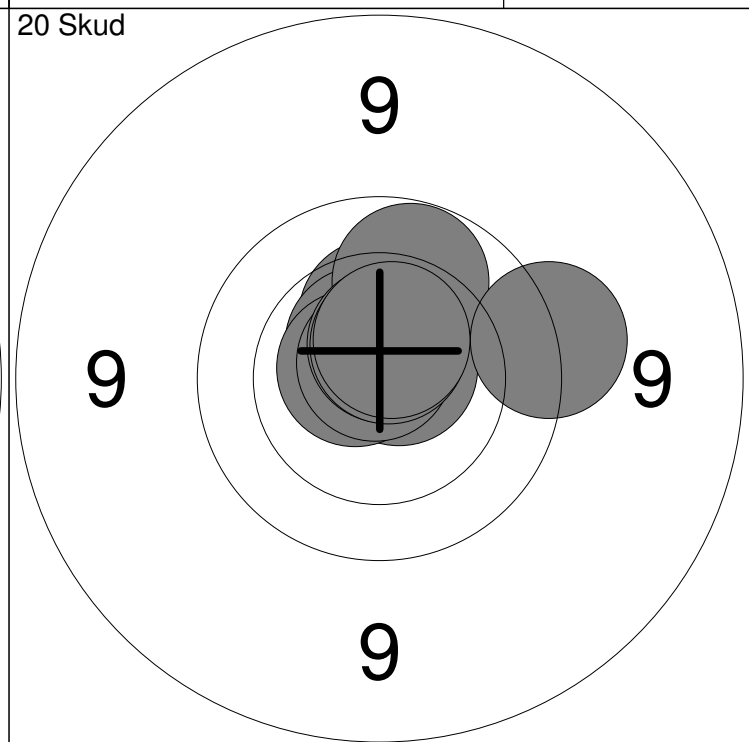
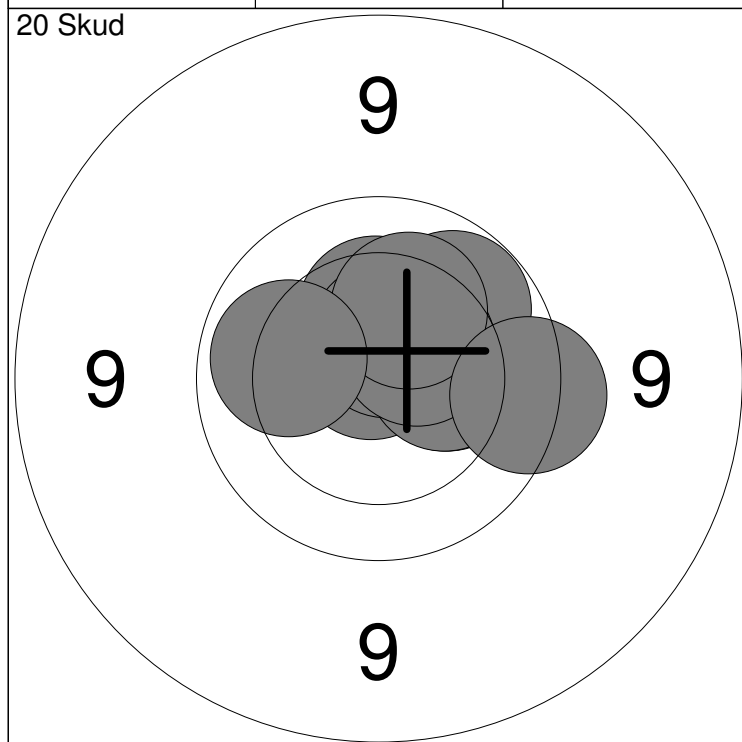

1: 10.3 →	6: 10.6x ↑	Serie	99
2: 10.8x ↑	7: 10.5 ↗		
3: 10.3 →	8: 10.2 ↑	Total	99
4: 10.0 ↗	9: 9.7 →		
5: 10.3 ↑	10: 10.1 ←		

11: 10.7x ↗	16: 10.0 ↑	Serie	99
12: 10.4 ↑	17: 10.6x ↑		
13: 10.6x ↖	18: 10.6x ↑	Total	198
14: 10.7x ←	19: 9.6 →		
15: 10.8x ↑	20: 10.6x ↑		

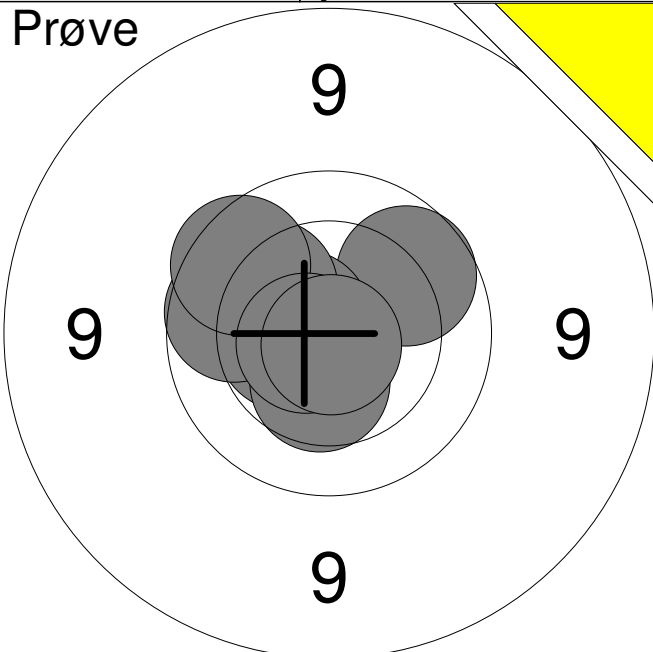
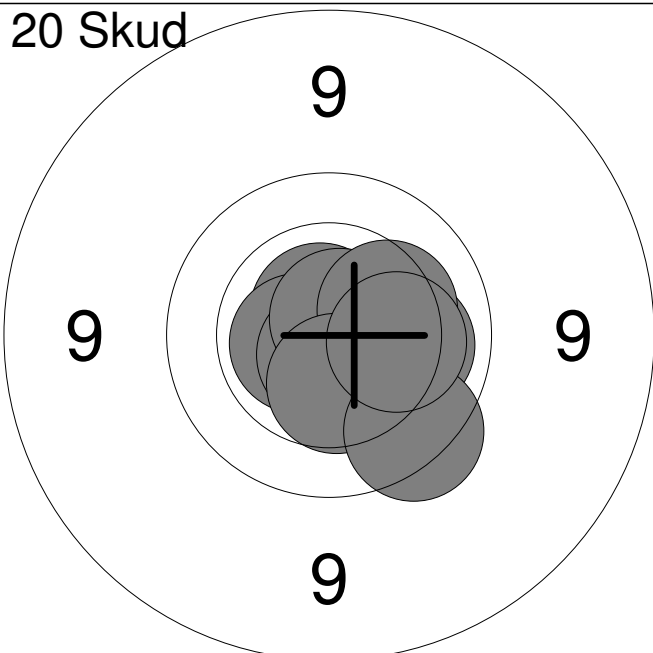
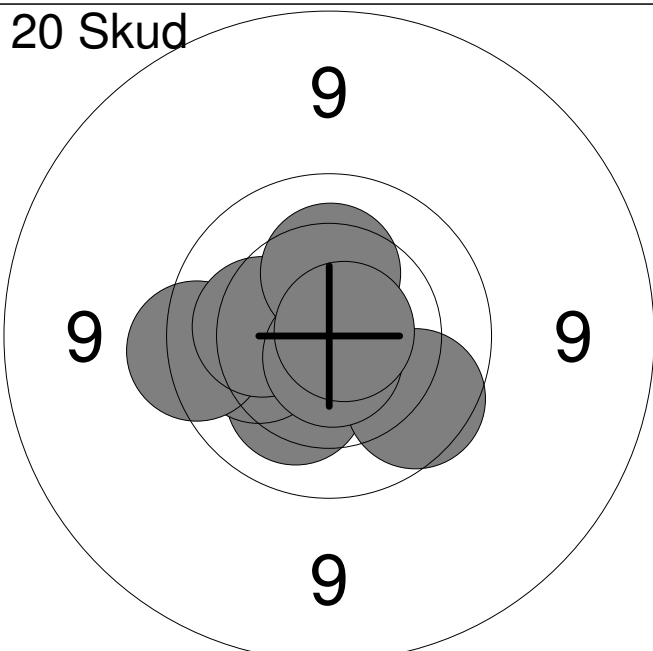
Hold	Skive	Jørgen Thomsen		
9	10	Hobro Egnens Skytteforening		VÅ1
AAS		Jyllandsstævne 2016		Aalborg Skyttekreds
Prøve		1:	9.9	↗
		2:	10.5	←
		3:	10.6x	↗
		4:	10.1	↗
		5:	9.9	←
		6:	9.8	↗
		7:	10.4	↓
		8:	10.7x	←
		9:	10.8x	↓
		Serie		87.0
Total		0.0		
20 Skud		1:	10.7x	↖
		2:	10.4	↓
		3:	10.6x	←
		4:	10.7x	↓
		5:	10.7x	↗
		6:	10.1	→
		7:	10.3	→
		8:	10.4	↓
		9:	9.7	↓
		10:	10.2	→
Serie		99.0		
Total		99.0		
20 Skud		11:	10.2	↙
		12:	10.7x	↑
		13:	10.2	←
		14:	9.7	←
		15:	10.7x	↑
		16:	10.2	←
		17:	10.3	↑
		18:	9.9	↘
		19:	10.7x	↓
		20:	10.8x	→
Serie		98.0		
Total		197.0		

Hold <b>9</b>	Skive <b>11</b>	<b>Birgitte Bonde</b>	
------------------	--------------------	-----------------------	--

AAS	Vodskov Skytteforening	MVÅ3
-----	------------------------	------

	Jyllandsstævne 2016	Aalborg Skyttekreds
--	---------------------	---------------------

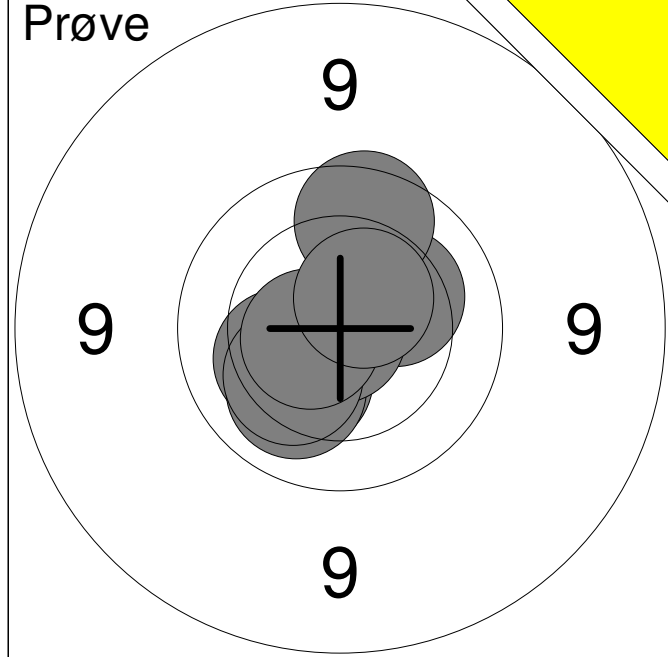

1:	10.3	↗
2:	10.3	↘
3:	10.3	↙
4:	9.8	↑
5:	10.1	↘
6:	10.9x	↘
7:	10.2	↙
8:	10.6x	↖
9:	10.5x	↗

Serie	89.0
-------	------

Total	0.0
-------	-----

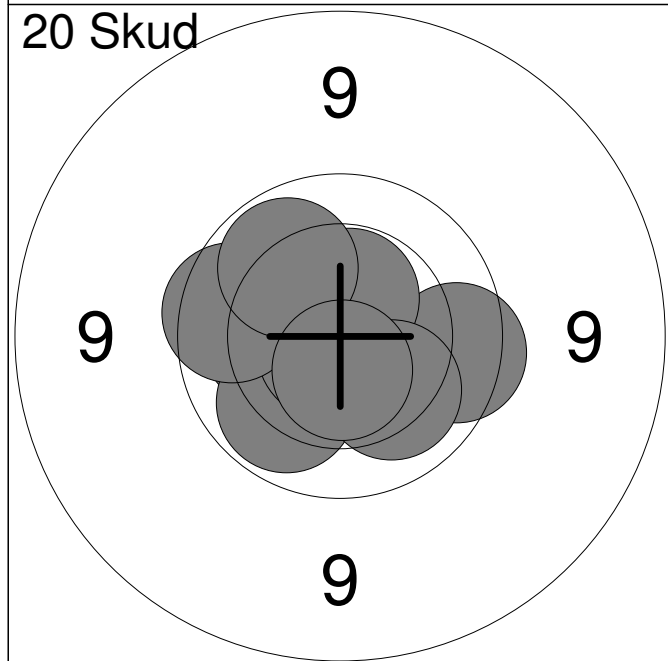

1:	9.8	→
2:	10.2	←
3:	10.0	↘
4:	10.7x	↑
5:	10.8x	↘
6:	10.5x	↑
7:	9.8	←
8:	10.1	↘
9:	10.0	↗
10:	10.6x	↓

Serie	98.0
-------	------

Total	98.0
-------	------

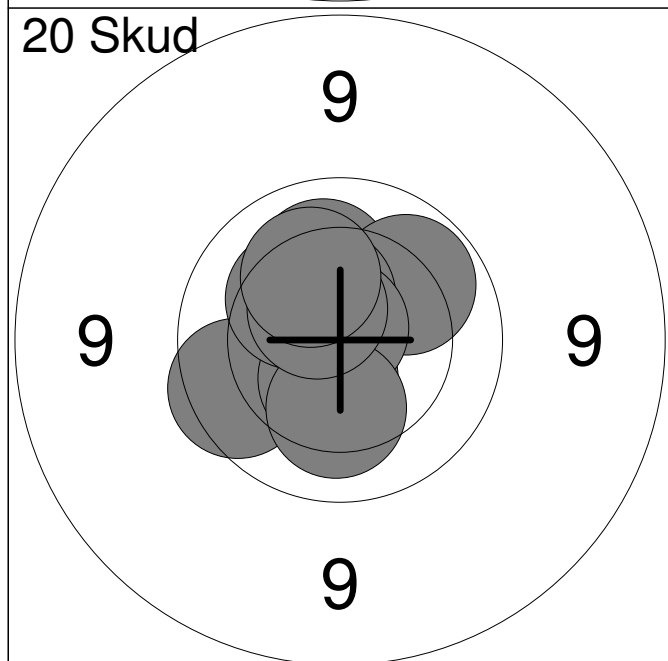

11:	9.8	←
12:	10.5x	↘
13:	10.2	↑
14:	10.3	↗
15:	10.0	↗
16:	10.5	↑
17:	10.8x	↑
18:	10.2	↘
19:	10.5x	↗
20:	10.2	↗

Serie	99.0
-------	------

Total	197.0
-------	-------

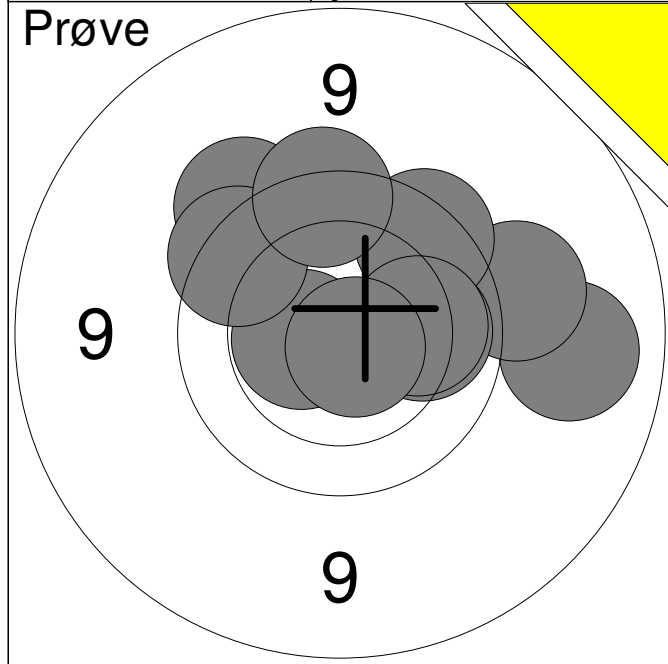

1:	9.5	↗
2:	9.1	→
3:	10.5x	←
4:	9.7	↗
5:	9.4	→
6:	10.1	→
7:	9.7	↗
8:	9.7	↑
9:	10.1	→
10:	10.7x	↘
<b>Serie</b>		<b>94.0</b>
<b>Total</b>		<b>0.0</b>

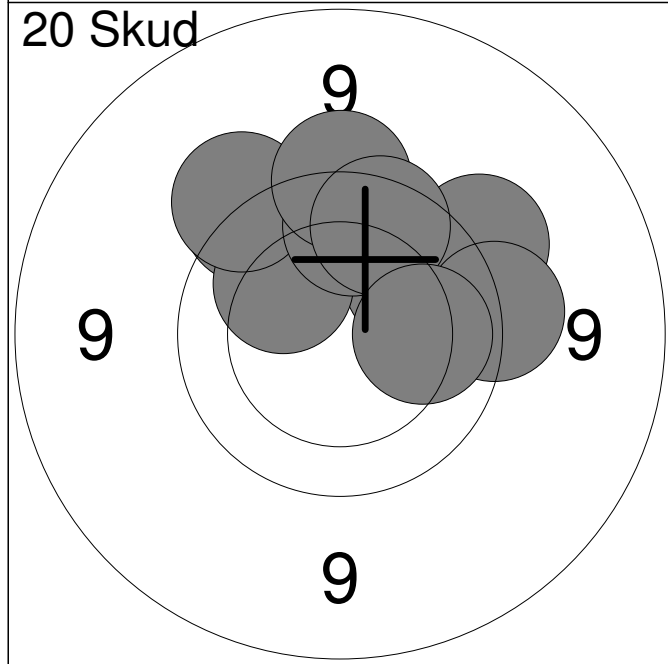

1:	9.9	↗
2:	9.5	↗
3:	9.6	→
4:	9.6	↗
5:	10.1	↗
6:	9.5	↗
7:	9.8	↑
8:	9.6	↑
9:	9.8	↑
10:	10.1	→
<b>Serie</b>		<b>92.0</b>
<b>Total</b>		<b>92.0</b>

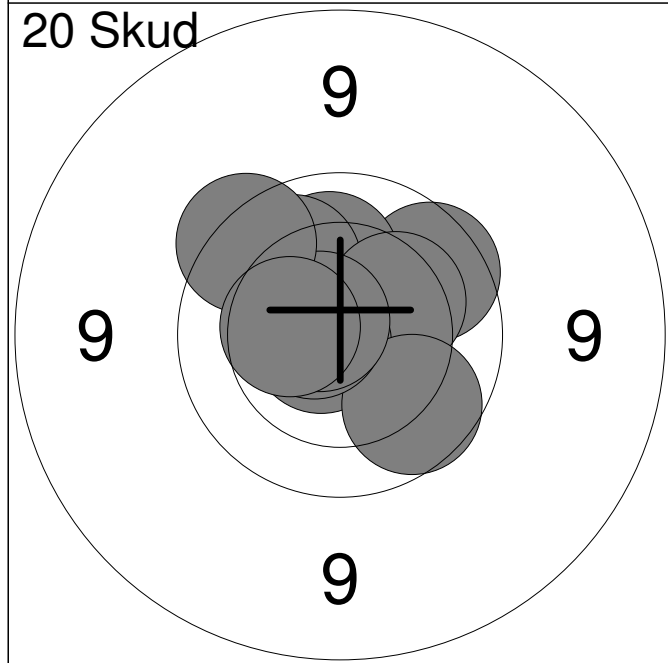

11:	9.8	↗
12:	10.1	↑
13:	10.0	↗
14:	10.3	↗
15:	10.7x	←
16:	9.9	↘
17:	10.7x	←
18:	10.7x	↗
19:	9.7	↗
20:	10.4	←
<b>Serie</b>		<b>97.0</b>
<b>Total</b>		<b>189.0</b>

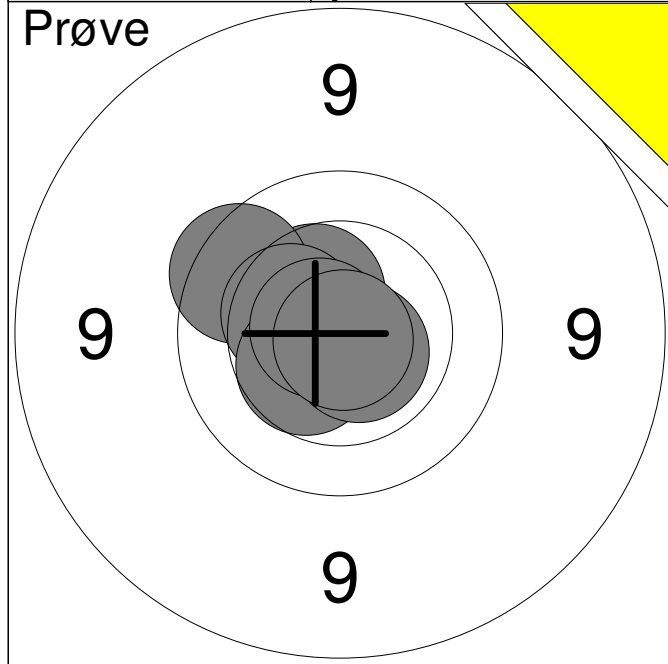

1:	10.4	↗
2:	9.8	↗
3:	10.4	↗
4:	10.4	↘
5:	10.7x	↗
6:	10.7x	↘
7:	10.9x	↘
<b>Serie</b>		<b>69.0</b>
<b>Total</b>		<b>0.0</b>

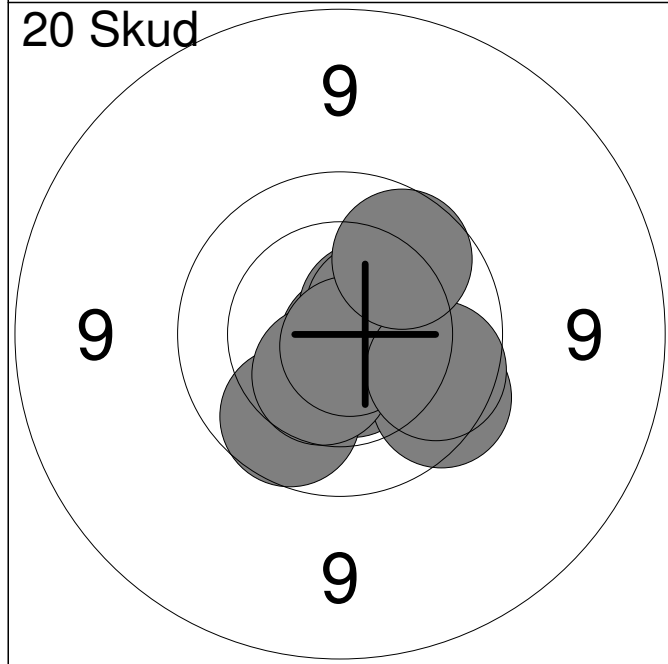

1:	10.6x	↘
2:	10.8x	↘
3:	9.9	↘
4:	9.8	↘
5:	10.6x	↗
6:	10.5	↘
7:	10.5	↗
8:	10.8x	↘
9:	9.9	→
10:	9.9	↗
<b>Serie</b>		<b>96.0</b>
<b>Total</b>		<b>96.0</b>

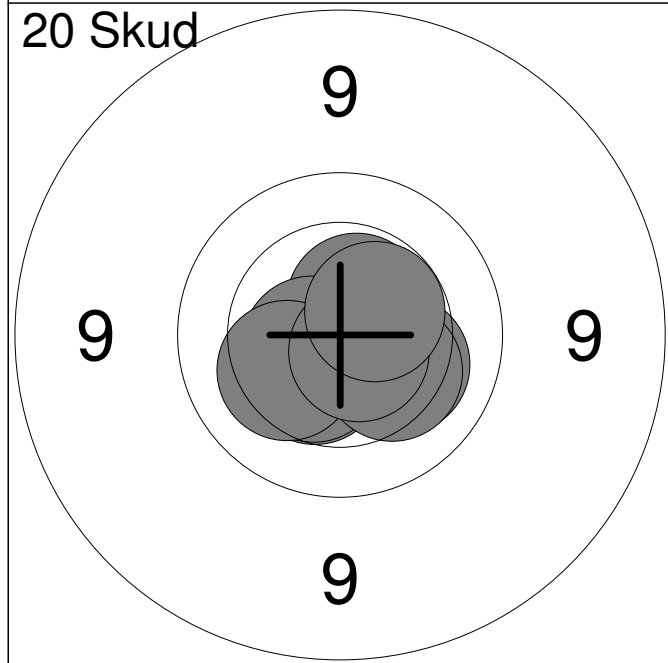

11:	10.5	↘
12:	10.7x	→
13:	10.6x	↗
14:	10.2	→
15:	10.6x	↙
16:	10.5	↘
17:	10.3	↙
18:	10.3	↘
19:	10.7x	↘
20:	10.5x	↗
<b>Serie</b>		<b>100.0</b>
<b>Total</b>		<b>196.0</b>

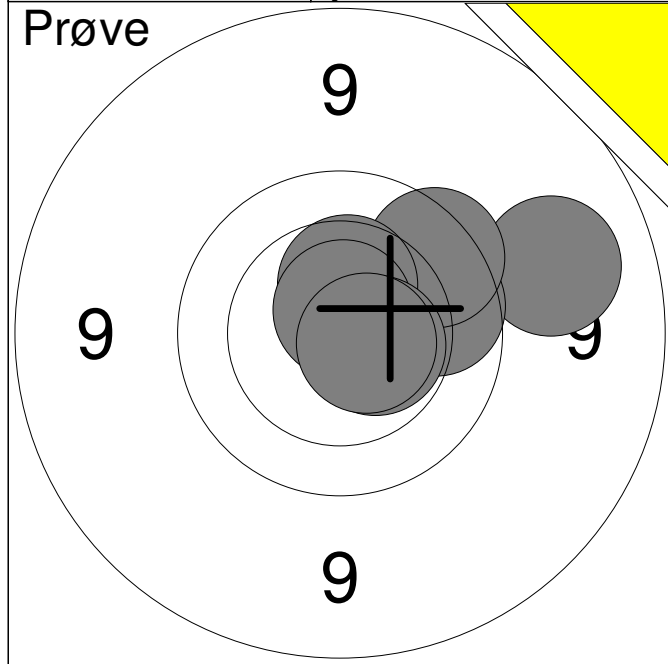

1:	9.2	→
2:	9.9	→
3:	9.8	↗
4:	10.4	↑
5:	10.7x	↑
6:	10.5x	→
7:	10.6x	→
<b>Serie</b>		<b>67.0</b>
<b>Total</b>		<b>0.0</b>

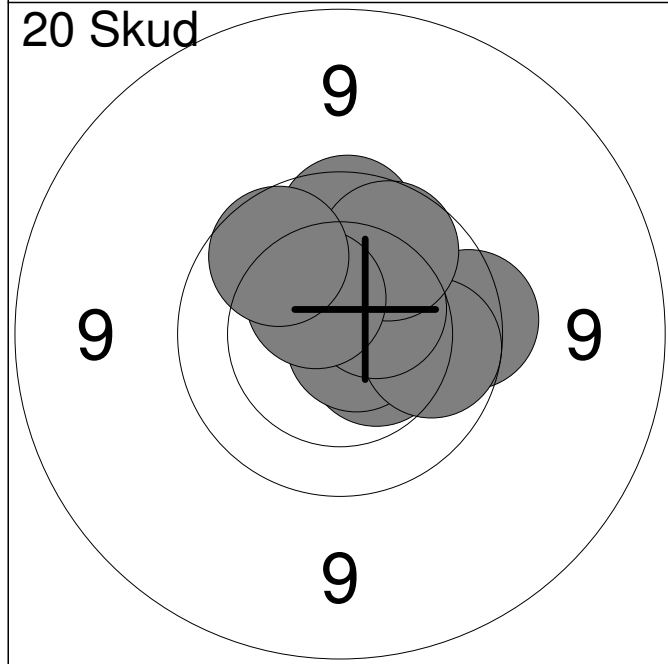

1:	9.7	→
2:	9.8	↑
3:	10.6x	→
4:	10.5x	↘
5:	10.8x	→
6:	9.9	→
7:	10.5	↗
8:	9.9	↗
9:	10.5	↗
10:	9.9	↗
<b>Serie</b>		<b>95.0</b>
<b>Total</b>		<b>95.0</b>

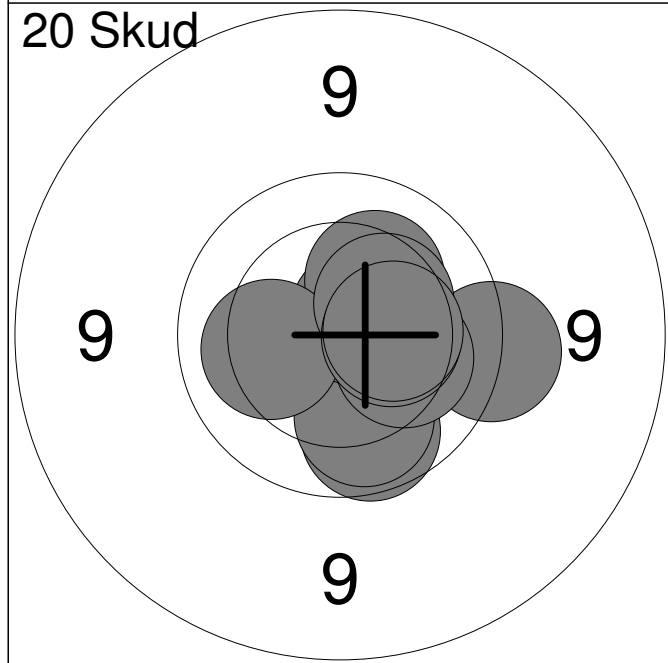

11:	9.9	↓
12:	10.0	↓
13:	9.6	→
14:	10.7x	↗
15:	10.3	↗
16:	10.2	←
17:	10.2	→
18:	10.4	↗
19:	10.4	→
20:	10.4	→
<b>Serie</b>		<b>98.0</b>
<b>Total</b>		<b>193.0</b>

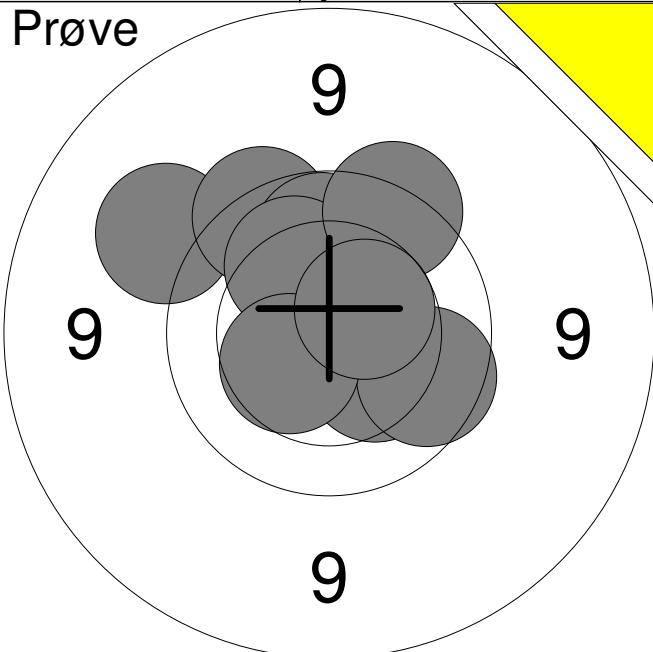
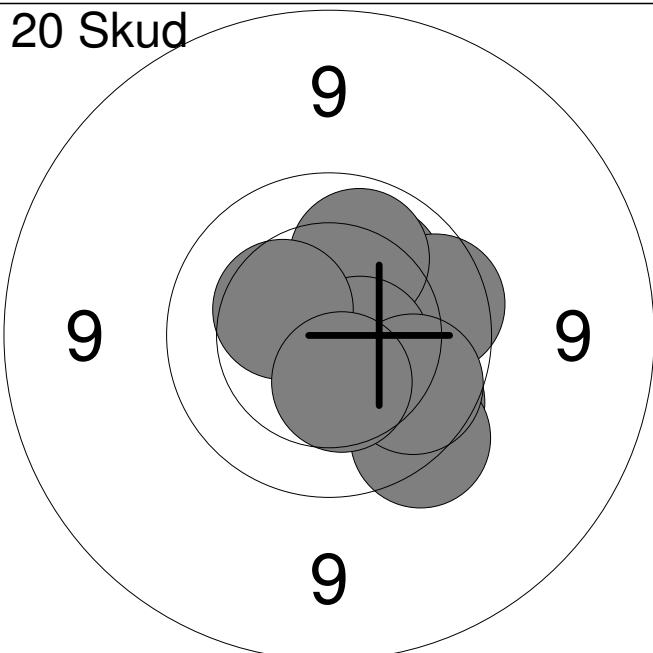
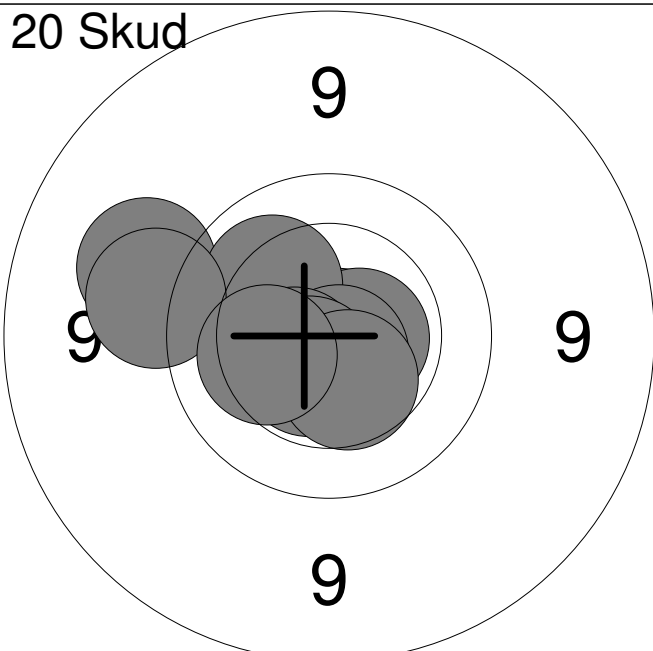
Hold	Skive	Kaj Haulrich	
AAS		Vodskov Skytteforening	MSE2
		Jyllandsstævne 2016	Aalborg Skyttekreds
Prøve		1: 9.3 ↗ 2: 9.7 ↗ 3: 10.0 ↑ 4: 10.1 ↗ 5: 9.7 ↗ 6: 10.3 ↓ 7: 9.9 ↓ 8: 10.4 ↙ 9: 10.5 ↗	
		Serie	86.0
		Total	0.0
20 Skud		1: 9.9 ↓ 2: 10.1 ↗ 3: 9.7 ↓ 4: 10.2 → 5: 9.8 → 6: 10.1 ↗ 7: 10.6x → 8: 9.9 ↓ 9: 10.4 ↗ 10: 10.4 ↓	
		Serie	96.0
		Total	96.0
20 Skud		11: 10.9x → 12: 10.6x → 13: 9.3 ↗ 14: 10.1 ↗ 15: 10.7x ↓ 16: 10.5x ↙ 17: 10.6x ↙ 18: 10.4 ↓ 19: 9.4 ↖ 20: 10.2 ↖	
		Serie	98.0
		Total	194.0



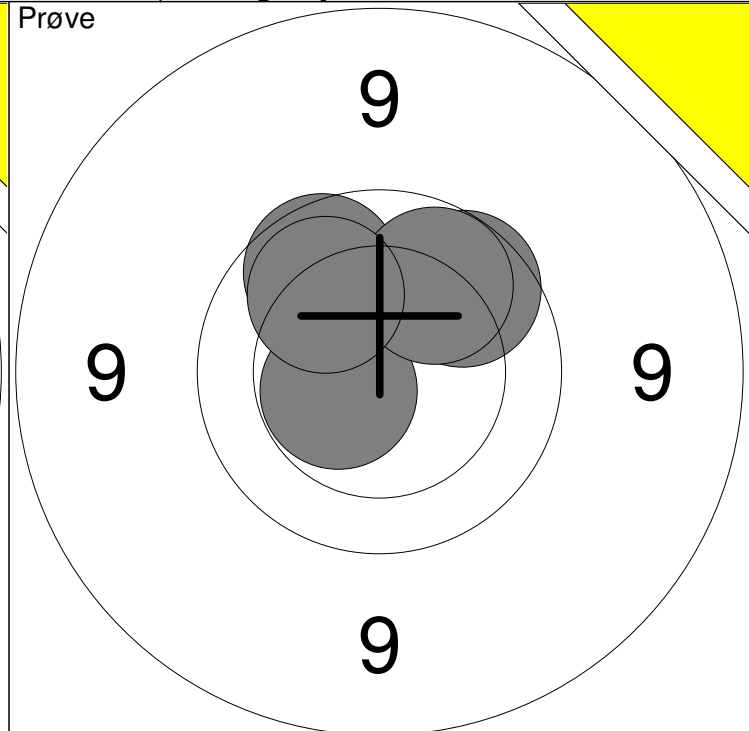
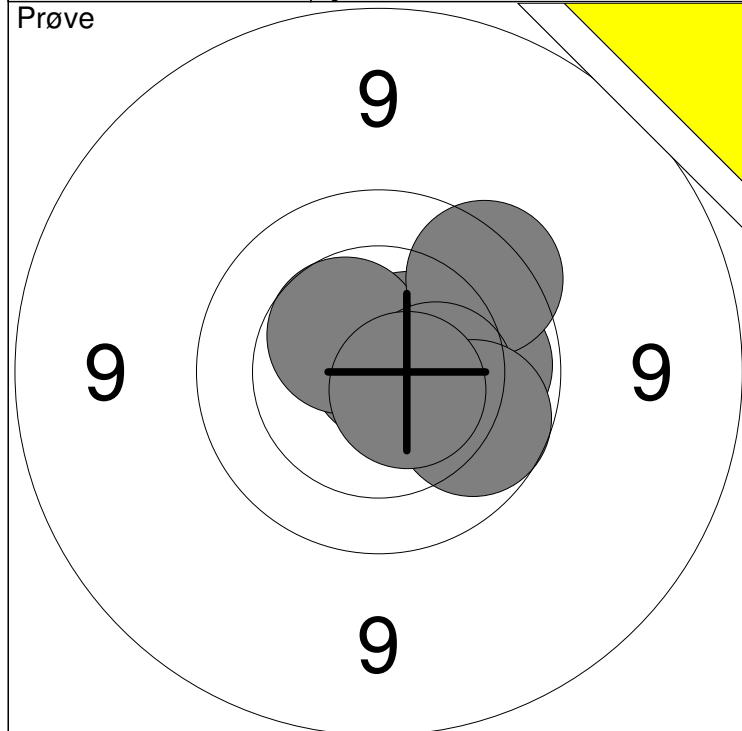

1: 10.6x ↗	6: 10.0 →	Serie	98
2: 10.8x ↗	7: 9.7 ↗		
3: 10.2 →	8: 10.4 →	Total	0
4: 10.5 ↗	9: 9.9 ↘		
5: 10.4 →	10: 10.6x ↘		

11: 9.9 ↗	Serie	48
12: 9.9 ↖		
13: 10.5x ↙	Total	0
14: 10.0 ↗		
15: 10.0 ↖		

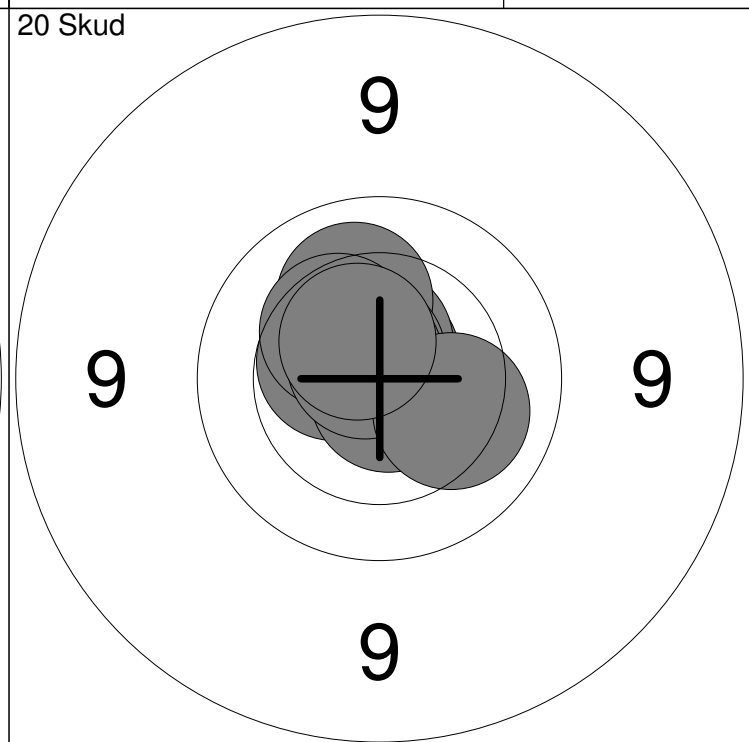
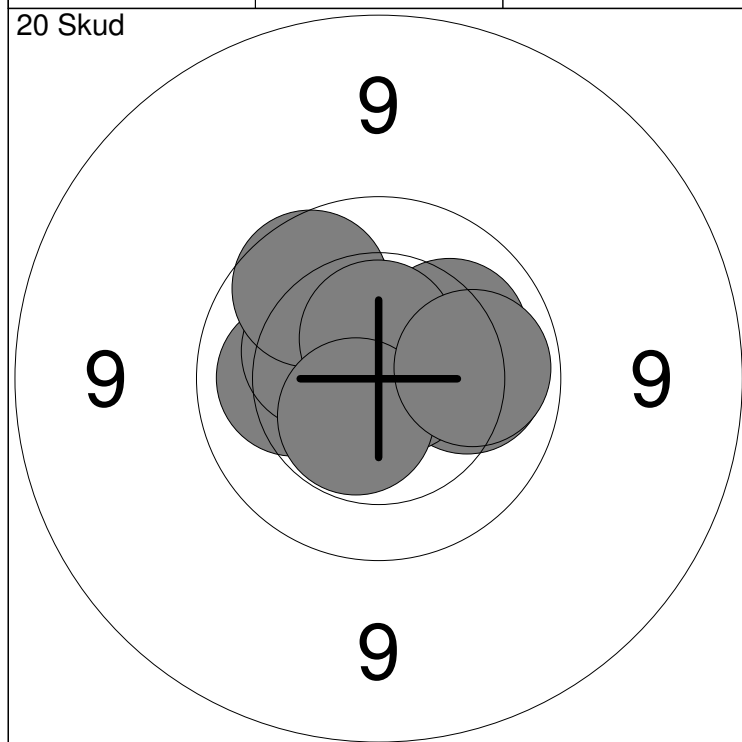

1: 10.2 ↗	6: 10.8x →	Serie	99
2: 10.1 →	7: 9.9 ↗		
3: 10.1 ←	8: 10.6x ↑	Total	99
4: 10.1 ↗	9: 10.5x ↘		
5: 10.3 ↖	10: 10.0 →		

11: 10.8x ↑	Serie	100
12: 10.5x ↙		
13: 10.6x ↑	Total	199
14: 10.2 ↗		
15: 10.7x ↖	16: 10.3 ↗	
	17: 10.8x ↘	
	18: 10.7x ↗	
	19: 10.2 ↘	
	20: 10.5x ↗	

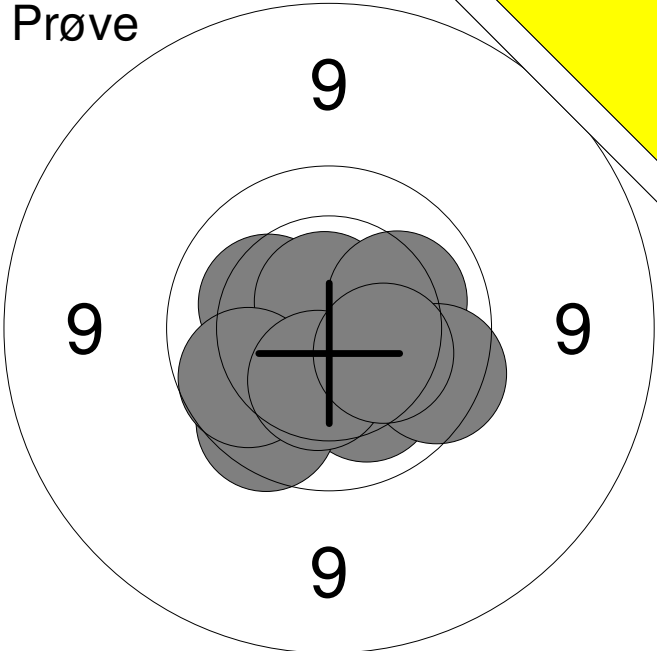
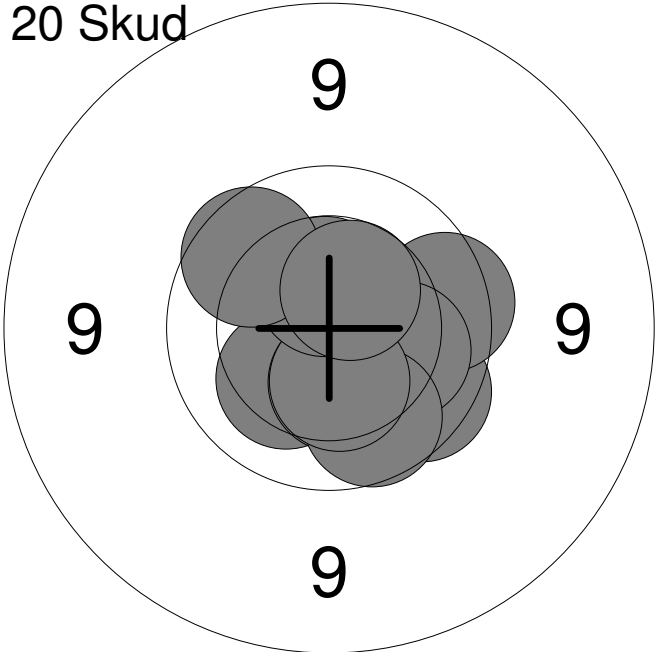
Hold	Skive		
10	5	Lea Larsen	
AAS	Vester Han Herred Skytteforenin		MB2
Jyllandsstævne 2016		Aalborg Skyttekreds	
Prøve		1: 10.2	↖
		2: 10.4	↓
		3: 10.7x	↑
		4: 10.2	→
		5: 10.2	↓
		6: 9.8	↙
		7: 9.8	→
		8: 9.9	↖
		9: 10.4	↓
		10: 10.3	→
		Serie	97.0
		Total	0.0
20 Skud		1: 10.2	↙
		2: 9.8	↘
		3: 10.4	↓
		4: 9.8	→
		5: 10.1	→
		6: 9.9	↙
		7: 10.4	↓
		8: 10.5x	↑
		9: 9.9	↗
		10: 10.5	↗
		Serie	96.0
		Total	96.0
20 Skud		11: 9.7	←
		12: 10.4	↗
		13: 10.5	←
		14: 10.1	←
		15: 10.1	→
		16: 9.9	↗
		17: 10.4	→
		18: 9.9	→
		19: 10.7x	↗
		20: 10.1	↖
		Serie	97.0
		Total	193.0

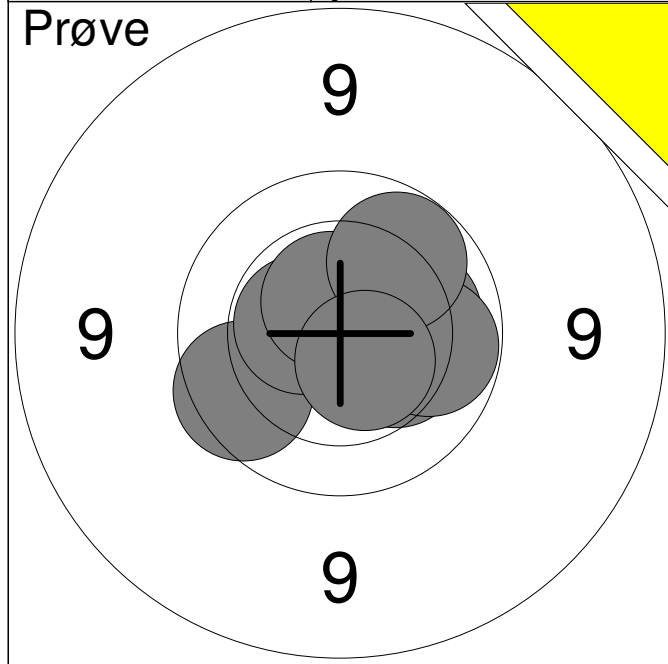

1:	10.3	→
2:	9.8	←
3:	10.2	→
4:	10.5x	←
5:	10.6x	↑
6:	10.0	→
7:	10.0	↗
8:	10.6x	↘
<b>Serie</b>		<b>79.0</b>
<b>Total</b>		<b>0.0</b>

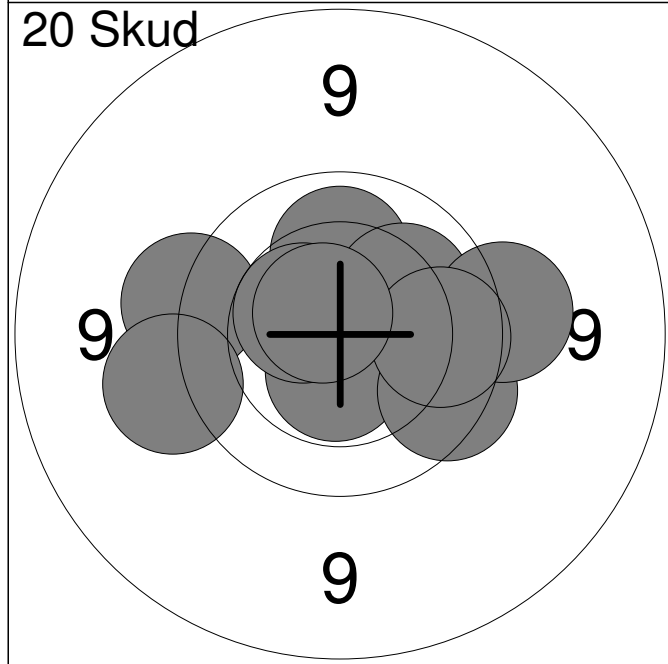

1:	10.1	↑
2:	10.5x	↓
3:	9.6	←
4:	10.5x	↖
5:	9.8	→
6:	10.1	↗
7:	9.5	→
8:	9.9	→
9:	10.7x	↗
10:	9.4	←
<b>Serie</b>		<b>95.0</b>
<b>Total</b>		<b>95.0</b>

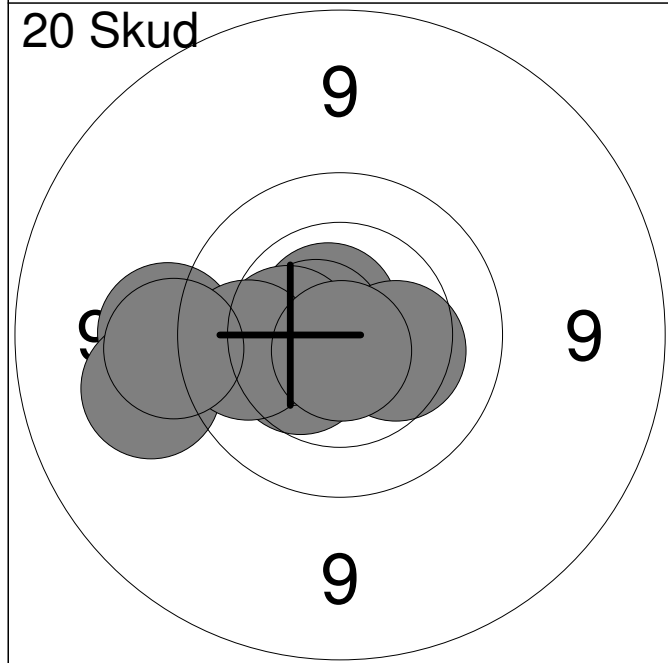

11:	10.7x	↖
12:	10.4	←
13:	9.5	←
14:	10.7x	←
15:	10.4	←
16:	9.3	←
17:	10.0	←
18:	10.3	→
19:	9.5	←
20:	10.8x	↓
<b>Serie</b>		<b>97.0</b>
<b>Total</b>		<b>192.0</b>

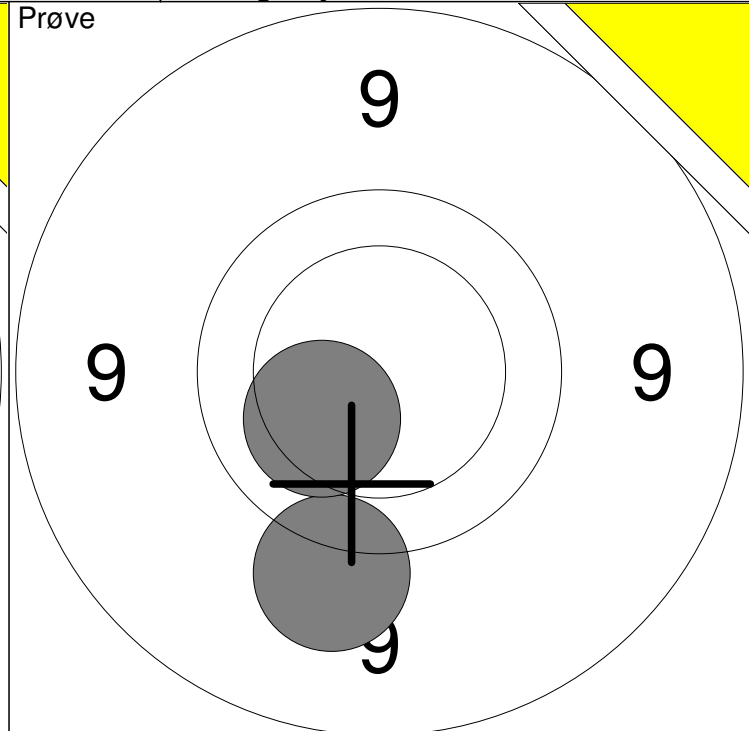
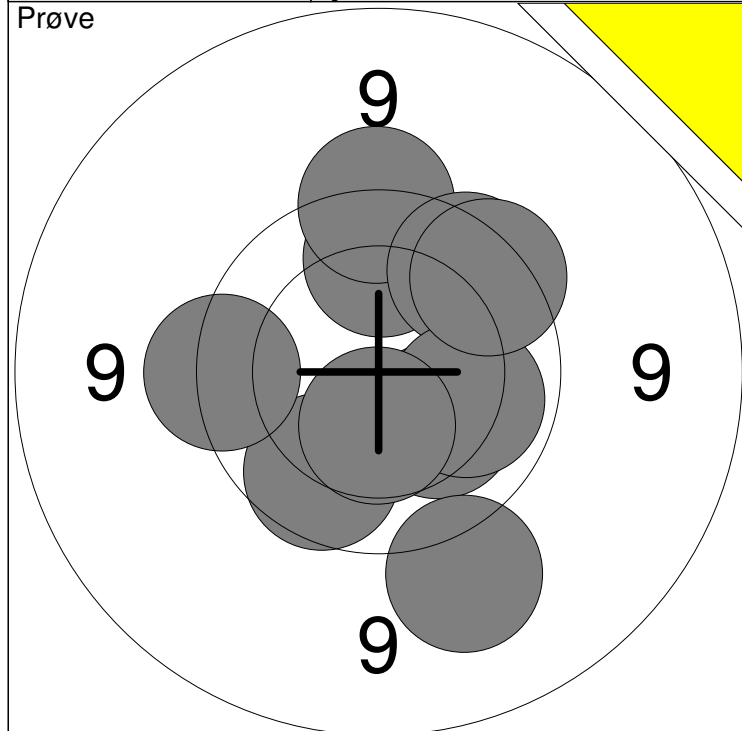

1: 9.9 ↘	6: 10.1 →	Serie	93
2: 9.9 ↑	7: 9.7 ←		
3: 9.6 ↑	8: 9.7 ↗	Total	0
4: 9.8 ↗	9: 10.4 ↓		
5: 10.2 ↘	10: 9.3 ↓		

11: 9.4 ↓	Serie	19
12: 10.2 ↙		
Total		0

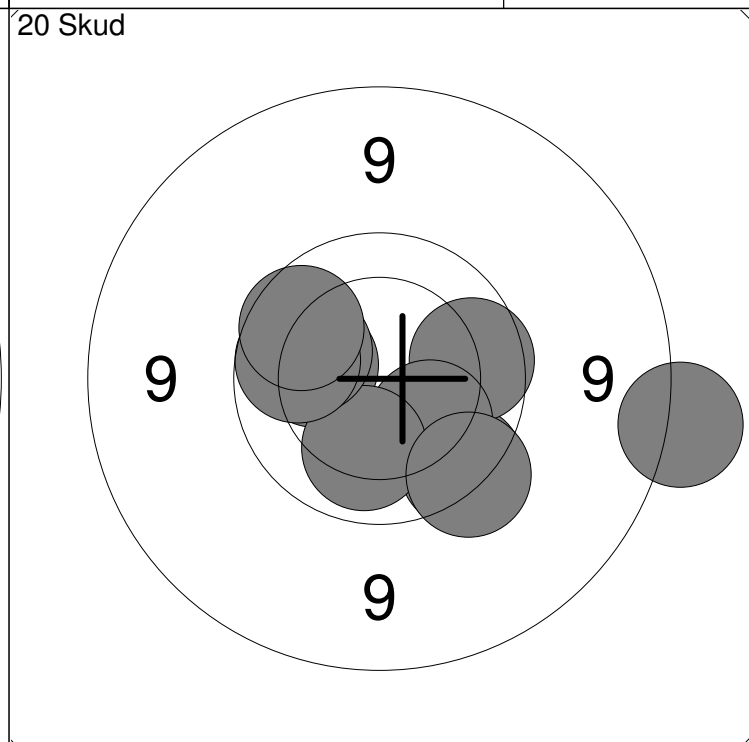
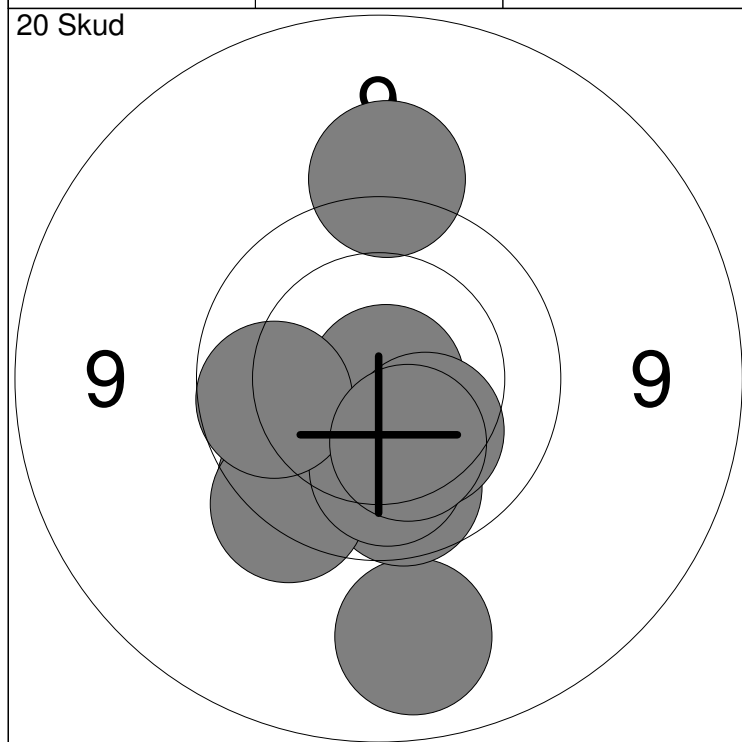

1: 10.9x ↘	6: 10.3 ↓	Serie	94
2: 9.1 ↓	7: 9.4 ↑		
3: 9.9 ↓	8: 10.1 ↓	Total	94
4: 9.8 ↙	9: 9.9 ←		
5: 9.7 ↙	10: 10.3 ↓		

11: 9.7 ↓	16: 9.6 ↓	Serie	93
12: 10.2 ←	17: 10.0 ↖		
13: 9.9 →	18: 9.9 ←	Total	187
14: 10.1 ↘	19: 8.6 →		
15: 10.1 ↓	20: 9.9 ↖		

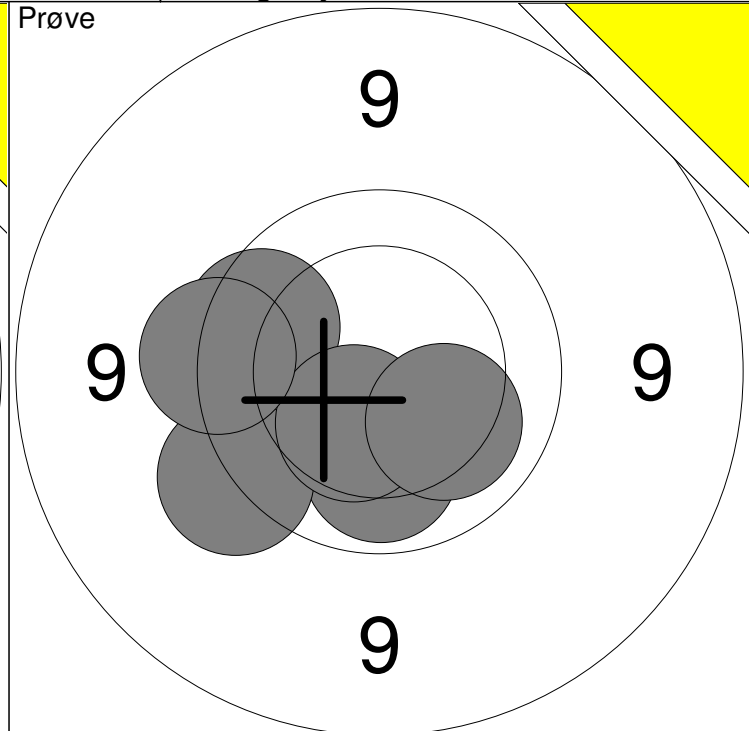
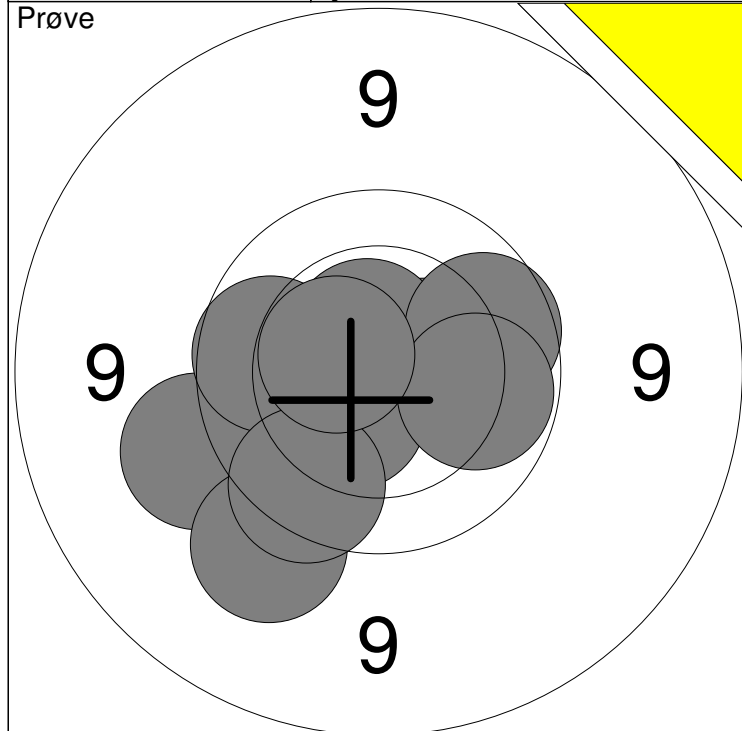

1: 10.5 →	6: 9.9 ←	Serie	95
2: 9.4 ←	7: 9.9 →		
3: 10.6x ↑	8: 9.8 ↓	Total	0
4: 10.5 ↓	9: 10.0 →		
5: 9.4 ↓	10: 10.5x ←		

11: 10.1 ↓	16: 10.2 ↘	Serie	57
12: 9.8 ←	13: 9.5 ←		
14: 10.4 ↓	15: 9.6 ←	Total	0

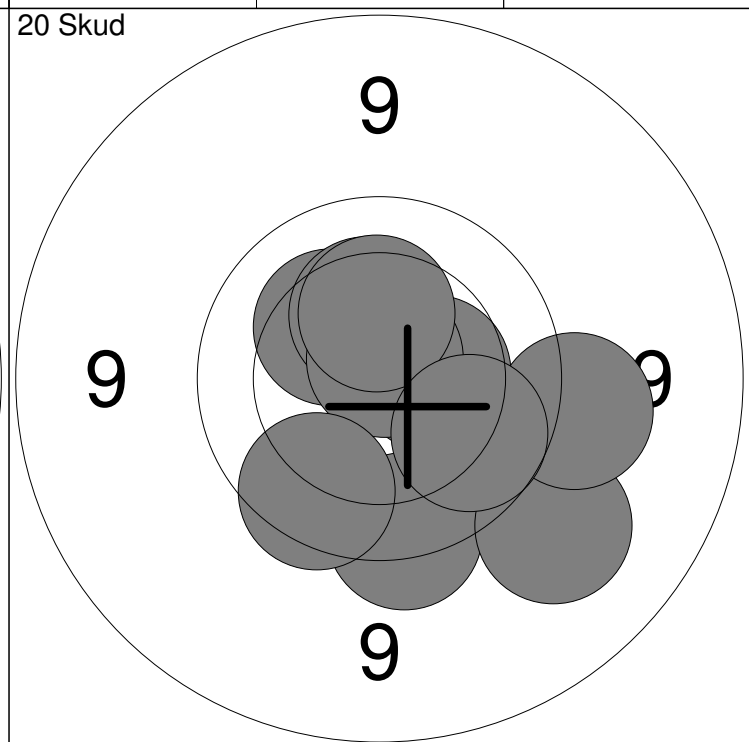
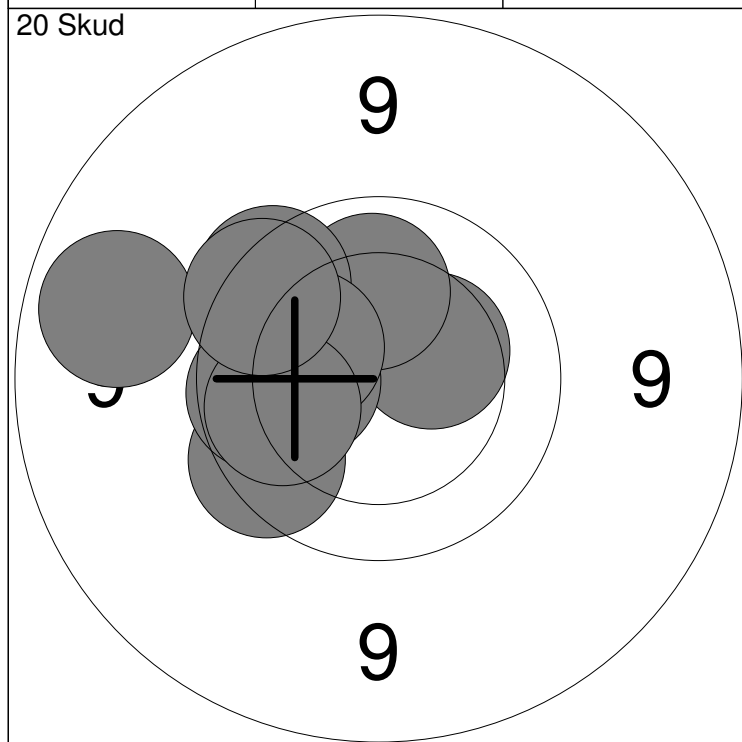

1: 10.4 →	6: 9.9 ←	Serie	95
2: 10.1 ↑	7: 10.2 ←		
3: 9.7 ←	8: 10.2 ←	Total	95
4: 9.8 ←	9: 10.0 ←		
5: 9.0 ←	10: 9.7 ↗		

11: 9.7 ↓	16: 10.3 ↑	Serie	95
12: 9.3 ↓	17: 10.8x ↑		
13: 10.3 ↗	18: 10.3 ↑	Total	190
14: 9.4 →	19: 9.8 ↓		
15: 10.4 →	20: 9.9 ↘		

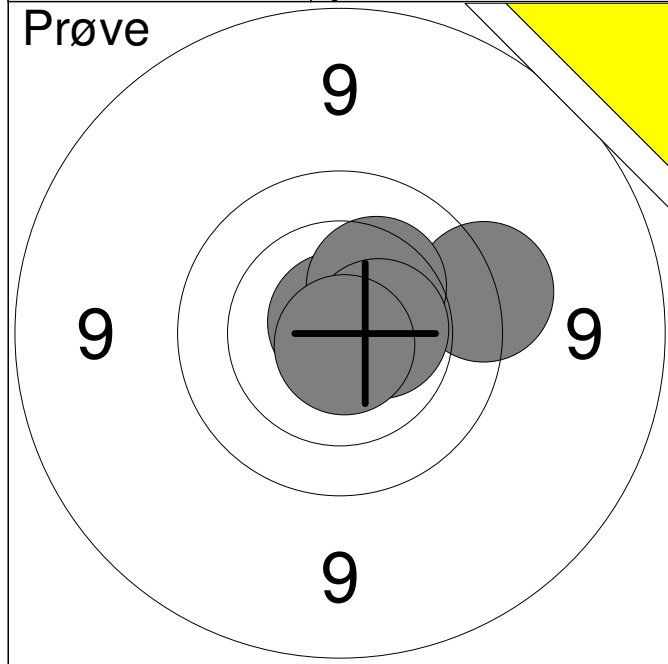

	1:	9.6	→
	2:	10.8x	↑
	3:	10.3	↗
	4:	10.5x	→
	5:	10.8x	↓
<b>Serie</b>			<b>49.0</b>
<b>Total</b>			<b>0.0</b>

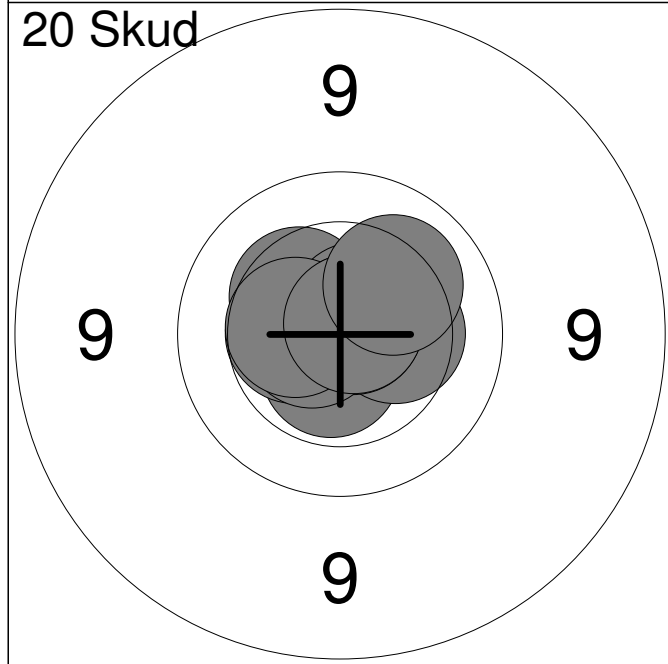

	1:	10.6x	↓
	2:	10.5	←
	3:	10.4	→
	4:	10.4	↖
	5:	10.6x	↗
	6:	10.8x	↗
	7:	10.6x	←
	8:	10.5	←
	9:	10.8x	↗
	10:	10.2	↗
<b>Serie</b>			<b>100.0</b>
<b>Total</b>			<b>100.0</b>

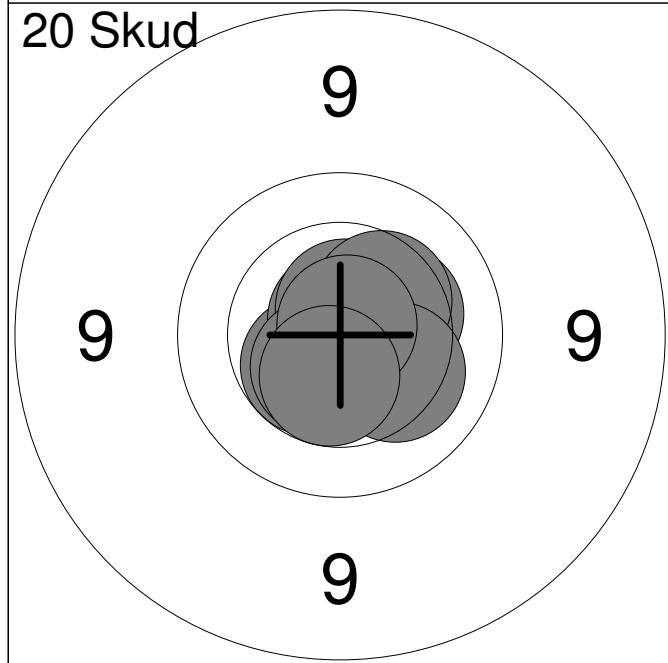

	11:	10.6x	→
	12:	10.5	↙
	13:	10.8x	↑
	14:	10.7x	↑
	15:	10.3	→
	16:	10.4	↗
	17:	10.2	↘
	18:	10.5x	↙
	19:	10.8x	↗
	20:	10.5x	↓
<b>Serie</b>			<b>100.0</b>
<b>Total</b>			<b>200.0</b>

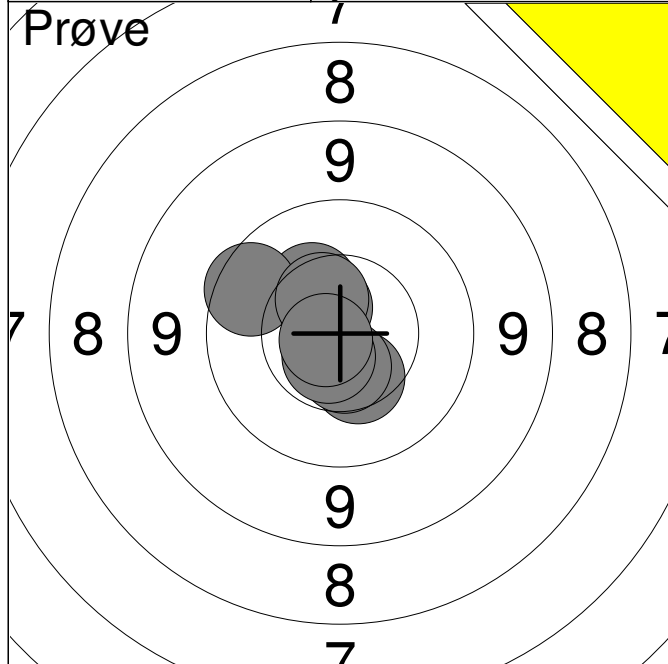

1:	10.3	↗
2:	9.8	↗
3:	10.4	↘
4:	10.6x	↗
5:	10.5	↗
6:	10.6	↘
7:	10.7x	↘
8:	10.8x	↙
<b>Serie</b>		<b>79.0</b>
<b>Total</b>		<b>0.0</b>

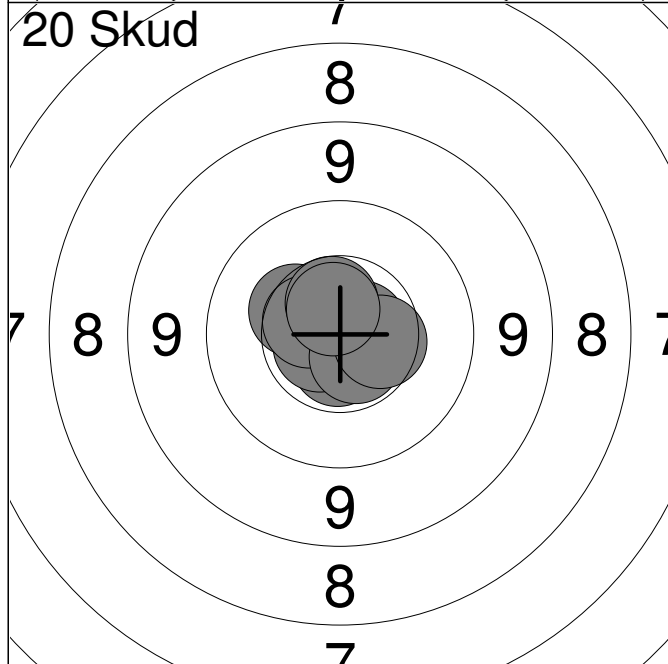

1:	10.7x	→
2:	10.9x	↓
3:	10.7x	↓
4:	10.7x	↙
5:	10.4	↗
6:	10.6	↗
7:	10.6	↗
8:	10.6x	↘
9:	10.5	→
10:	10.6x	↗
<b>Serie</b>		<b>100.0</b>
<b>Total</b>		<b>100.0</b>

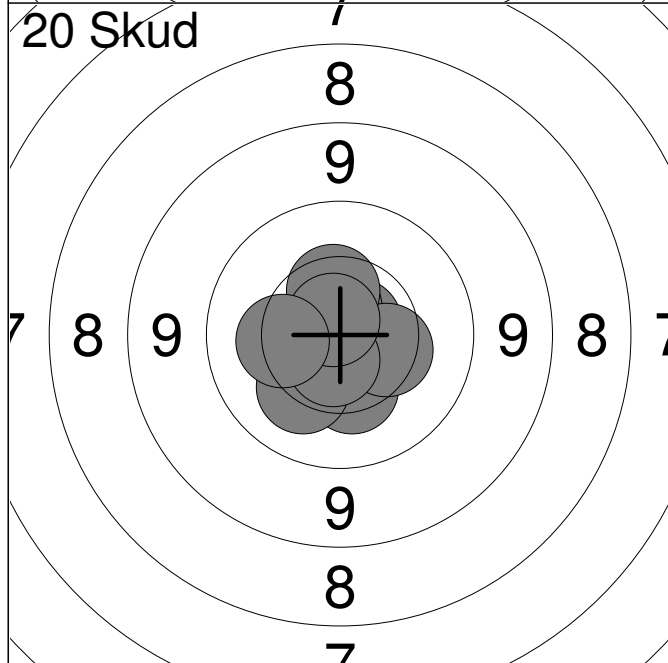

11:	10.7x	↗
12:	10.7x	↗
13:	10.3	↓
14:	10.2	↙
15:	10.6x	↗
16:	10.4	→
17:	10.7x	↘
18:	10.4	↗
19:	10.8x	↗
20:	10.3	↙
<b>Serie</b>		<b>100.0</b>
<b>Total</b>		<b>200.0</b>

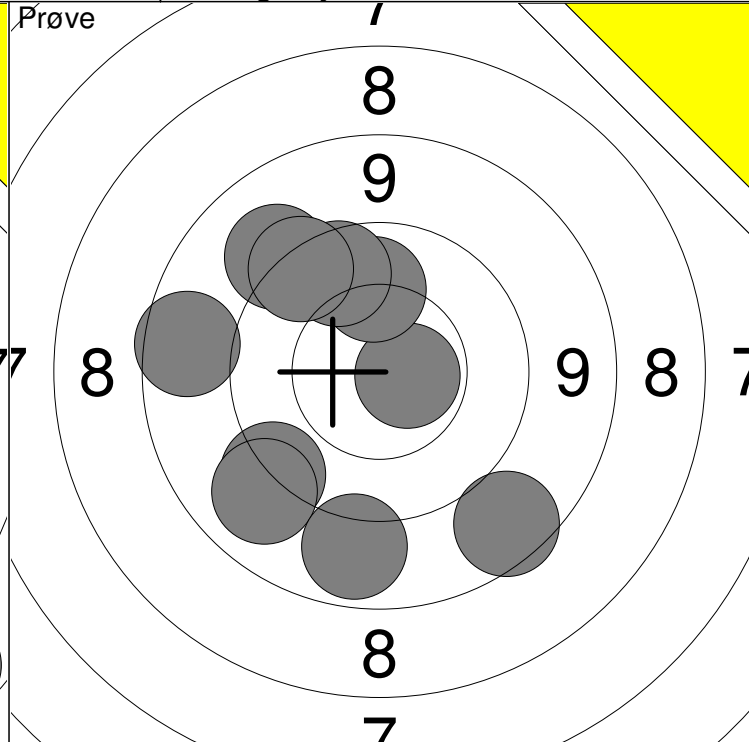
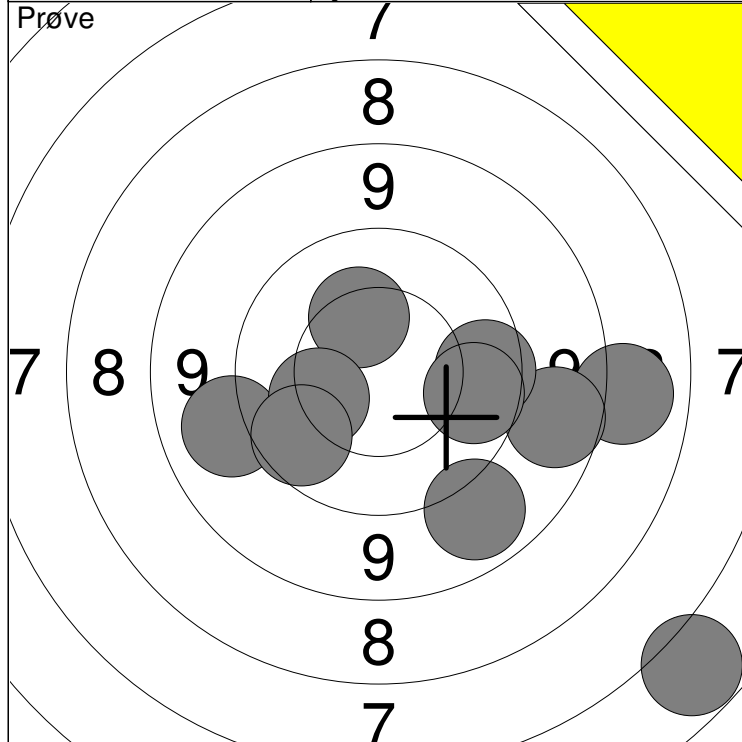

1: 6.0 ↘	6: 10.2 ←	Serie	87
2: 8.1 →	7: 8.9 →		
3: 9.2 ←	8: 9.8 →	Total	0
4: 9.1 ↘	9: 9.9 ↙		
5: 10.3 ↗	10: 9.9 →		

11: 10.7x →	16: 9.2 ↙	Serie	90
12: 8.8 ←	17: 9.0 ↘		
13: 9.4 ↙	18: 8.8 ↘	Total	0
14: 9.3 ↗	19: 9.8 ↗		
15: 10.1 ↗	20: 9.6 ↗		

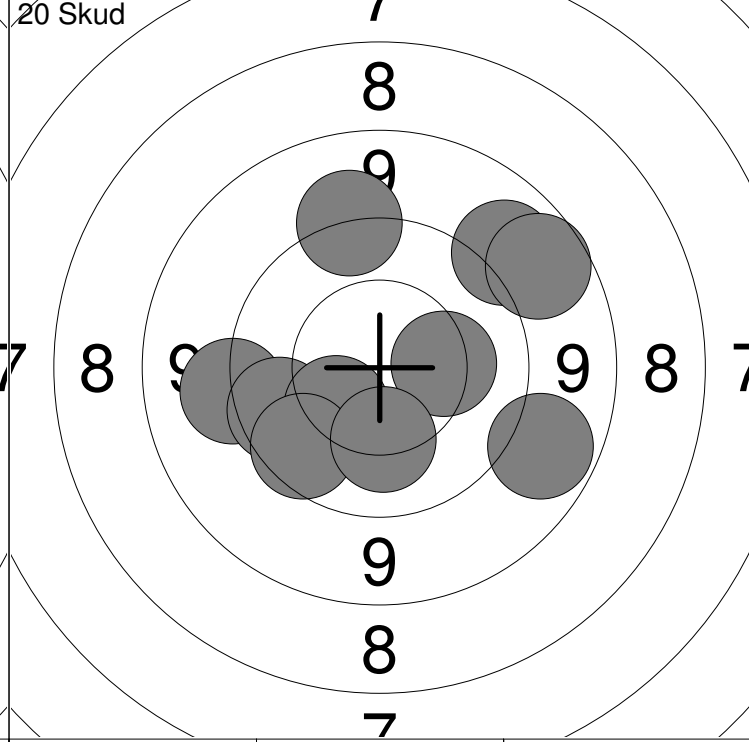
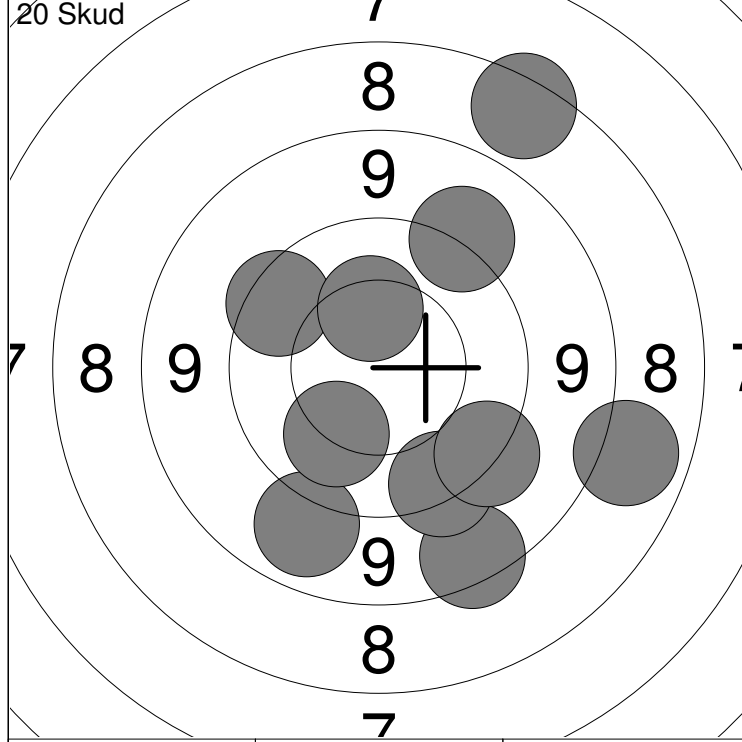

1: 8.7 ↘	6: 9.5 ↘	Serie	88
2: 9.1 ↘	7: 9.7 ↗		
3: 9.5 ↘	8: 10.1 ↘	Total	88
4: 7.7 ↗	9: 8.1 →		
5: 9.3 ↗	10: 10.3 ↗		

11: 9.4 ←	16: 9.0 →	Serie	92
12: 9.4 ↗	17: 10.3 ↘		
13: 10.3 →	18: 9.8 ↘	Total	180
14: 9.8 ←	19: 10.2 ↘		
15: 9.1 ↗	20: 8.9 ↗		

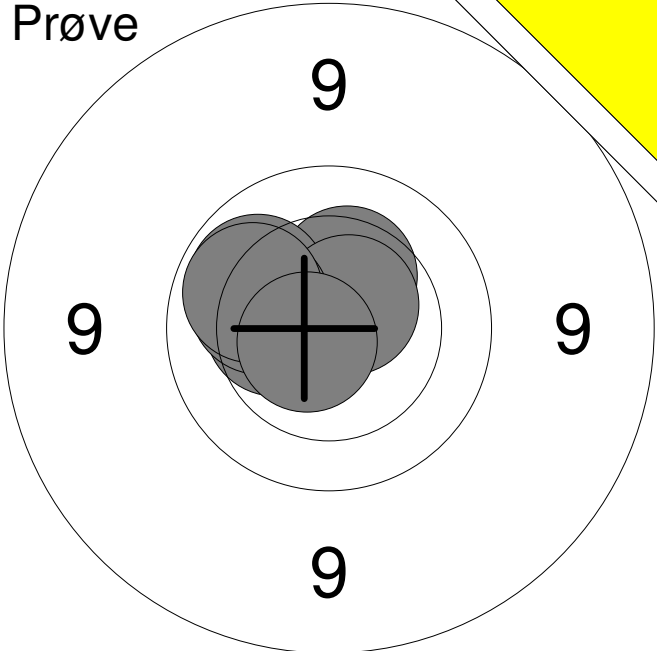
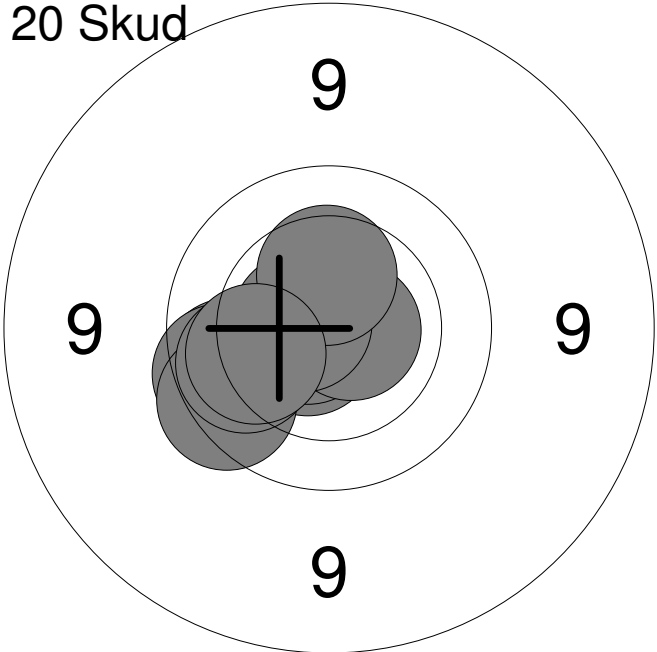
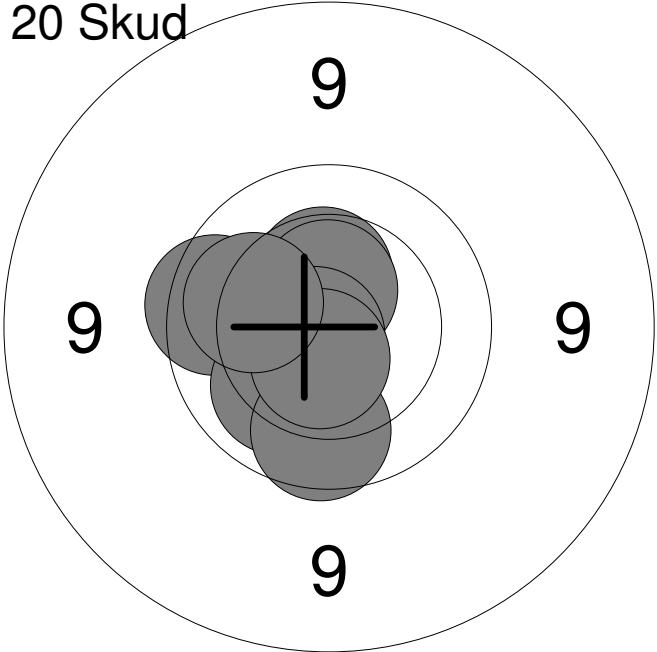

Hold	Skive	Mads Tinggaard Larsen	
AAS		Vester Han Herred Skytteforenin	MVÅ2
		Jyllandsstævne 2016	Aalborg Skyttekreds
Prøve		1: 10.4 ↑ 2: 10.0 ↖ 3: 10.6x ↗ 4: 10.4 ← 5: 10.2 ↖ 6: 10.0 ↖ 7: 10.7x ↙	Serie 70.0 Total 0.0
20 Skud		1: 9.9 ← 2: 10.6x ↙ 3: 10.7x ← 4: 9.8 ← 5: 10.7x → 6: 10.6x ← 7: 10.4 ↑ 8: 9.8 ↙ 9: 10.0 ← 10: 10.1 ↙	Serie 97.0 Total 97.0
20 Skud		11: 9.8 ← 12: 10.4 ← 13: 10.6x ↑ 14: 10.1 ↙ 15: 10.4 ↑ 16: 10.5x ↑ 17: 9.9 ↓ 18: 10.8x ↙ 19: 10.6x ↓ 20: 10.1 ←	Serie 98.0 Total 195.0

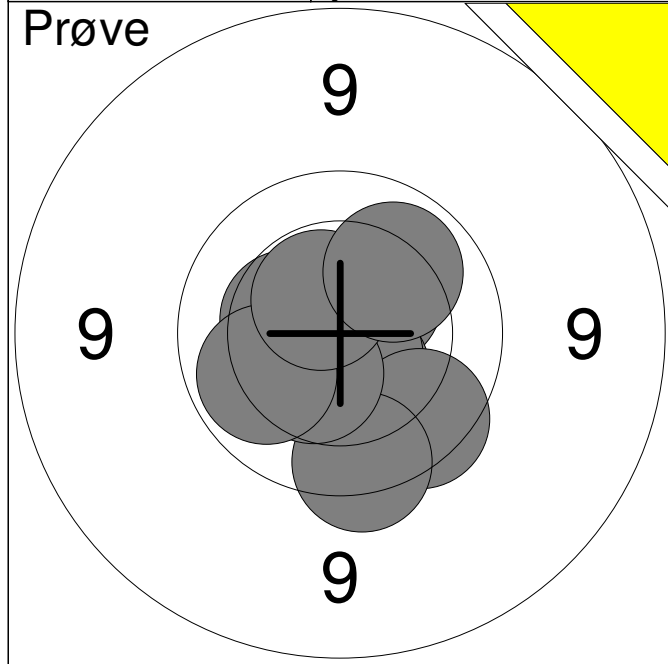

1:	10.4	↗
2:	10.5	↘
3:	10.7x	↘
4:	9.8	↘
5:	9.7	↘
6:	10.4	↖
7:	10.4	↘
8:	10.0	↖
9:	10.5x	↗
10:	10.1	↗
<b>Serie</b>		<b>98.0</b>
<b>Total</b>		<b>0.0</b>

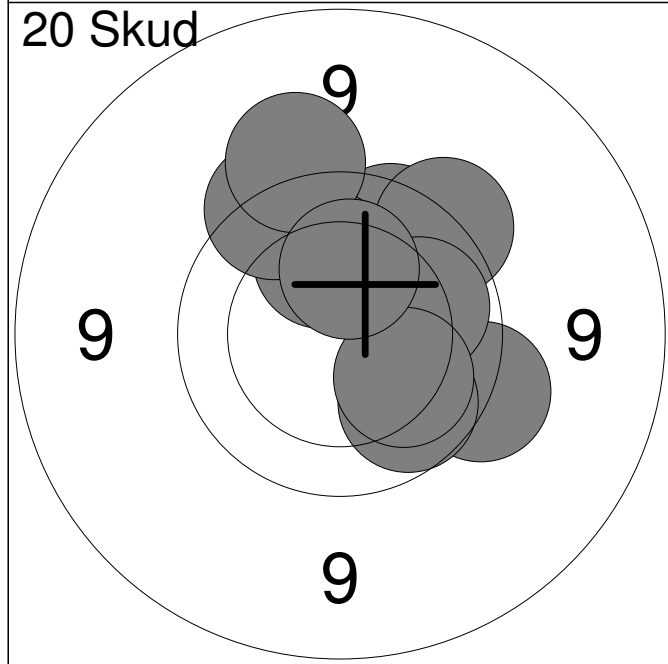

1:	9.8	↗
2:	9.6	↗
3:	9.6	→
4:	9.9	↘
5:	10.1	↗
6:	9.7	↗
7:	10.0	→
8:	10.1	↘
9:	9.4	↗
10:	10.2	↗
<b>Serie</b>		<b>94.0</b>
<b>Total</b>		<b>94.0</b>

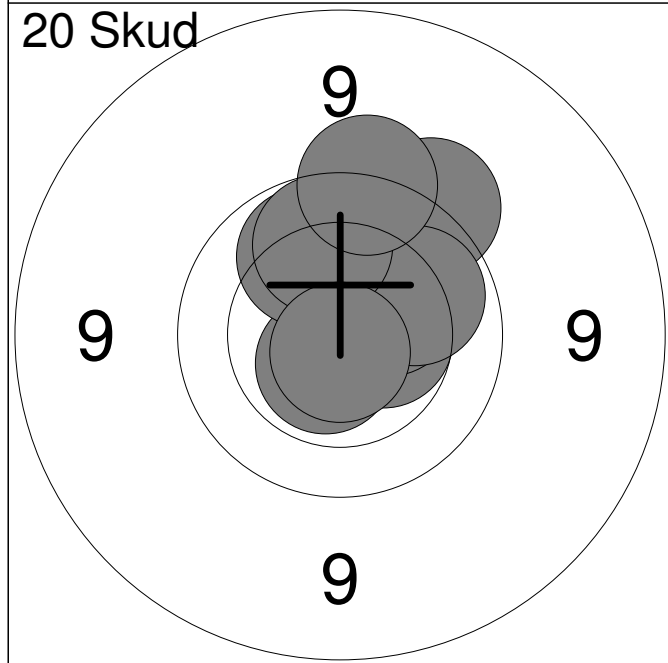

11:	9.6	↗
12:	10.5	↗
13:	10.6x	↘
14:	10.5	→
15:	10.4	↗
16:	10.0	↗
17:	10.0	↗
18:	10.0	↗
19:	9.6	↗
20:	10.8x	↘
<b>Serie</b>		<b>98.0</b>
<b>Total</b>		<b>192.0</b>

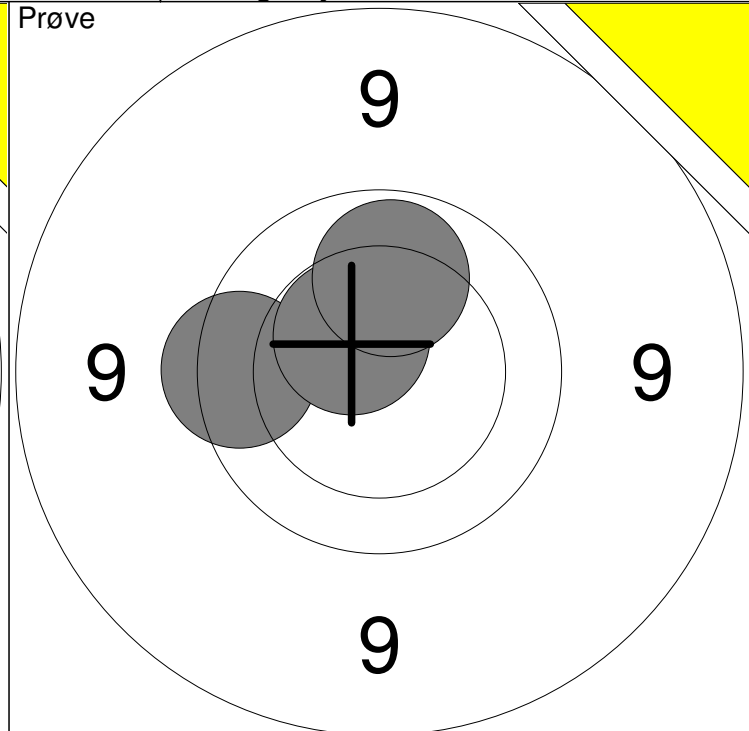
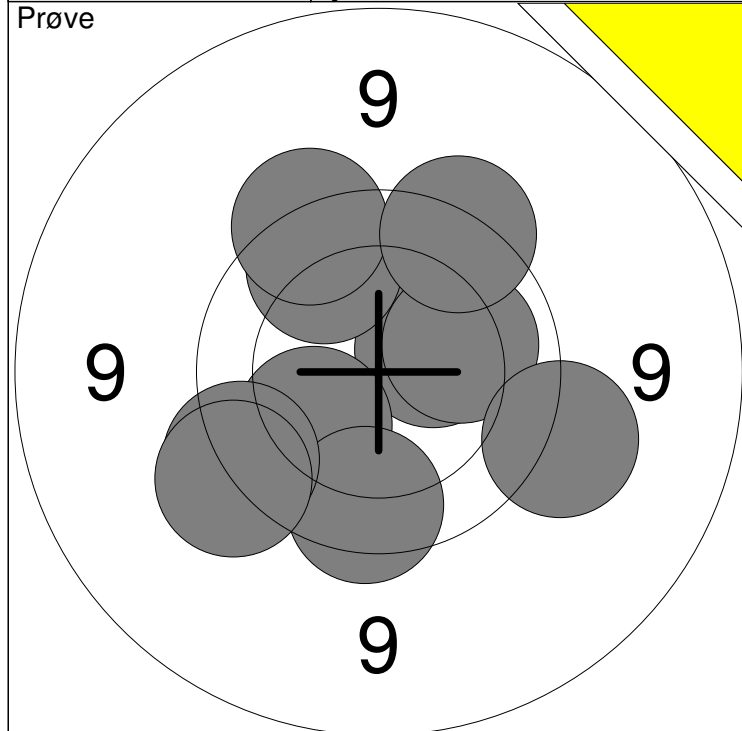

1: 10.4 →	6: 9.5 ↙	Serie	93
2: 9.9 ↗	7: 10.1 →		
3: 10.1 ↙	8: 9.5 →	Total	0
4: 9.8 ↓	9: 9.6 ↗		
5: 9.6 ↙	10: 9.6 ↗		

11: 9.8 ←	Serie	29
12: 10.5x ↗		
13: 10.0 ↑	Total	0

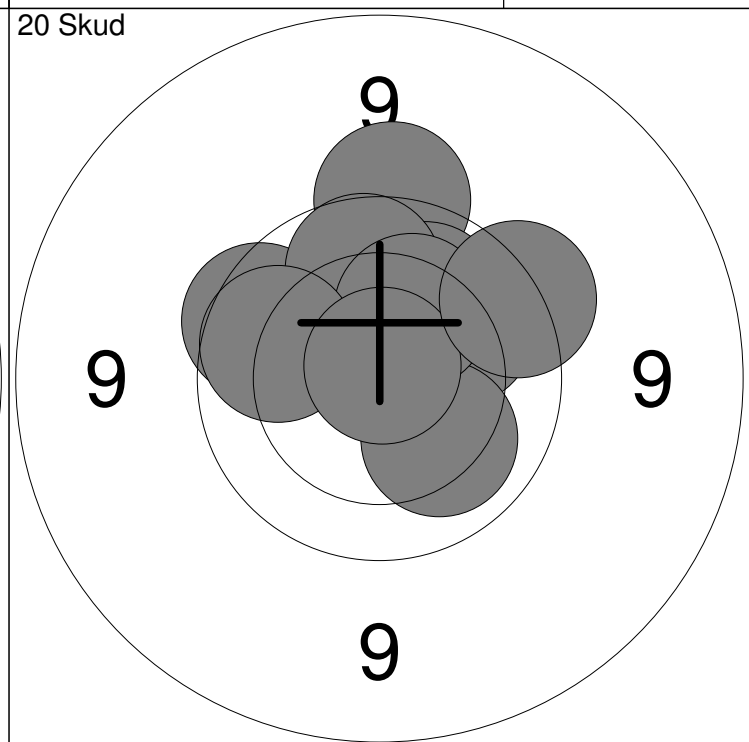
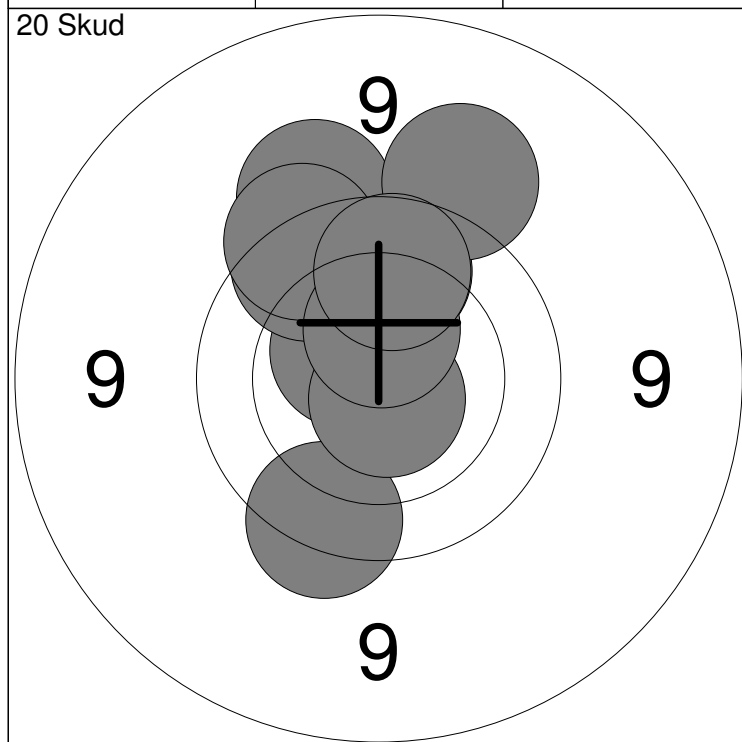

1: 9.7 ↙	6: 9.7 ↗	Serie	93
2: 10.6x ↗	7: 9.4 ↗		
3: 9.9 ↗	8: 10.7x ↙	Total	93
4: 9.8 ↗	9: 10.5 ↑		
5: 9.5 ↗	10: 9.9 ↑		

11: 10.1 ↗	16: 10.1 ↙	Serie	95
12: 9.5 ↑	17: 10.2 ↗		
13: 10.1 ↗	18: 9.9 ←	Total	188
14: 9.8 ←	19: 10.8x ↑		
15: 9.9 ↑	20: 9.6 ↗		

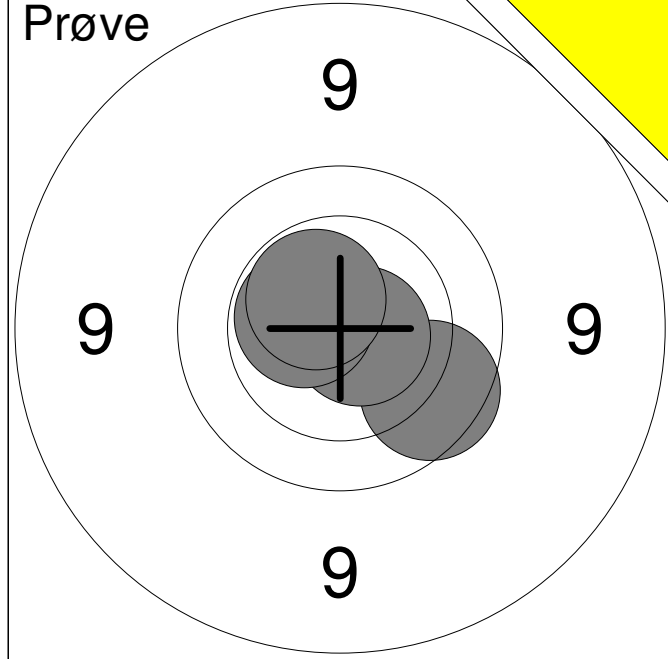

1:	9.8	↘
2:	10.7x	↘
3:	10.5x	↗
4:	10.5x	↗
Serie		39.0
Total		0.0

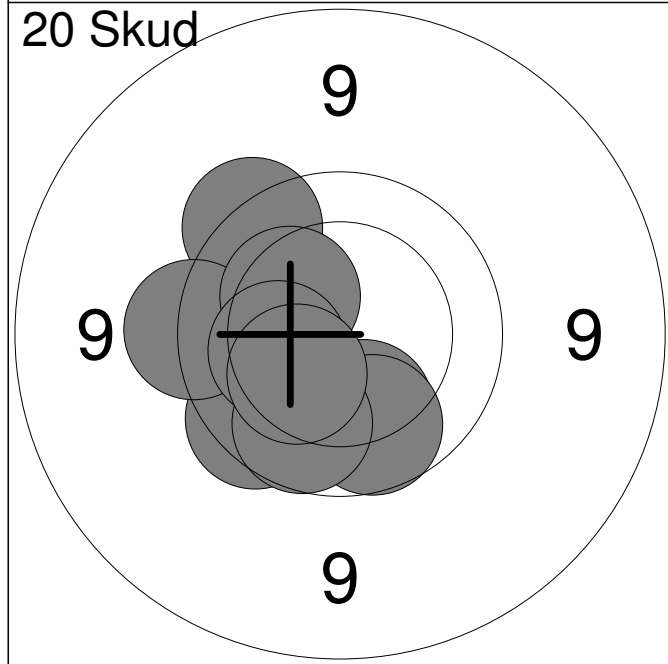

1:	10.1	↘
2:	9.9	↘
3:	9.8	↖
4:	10.1	↗
5:	9.9	↘
6:	9.7	↗
7:	9.6	←
8:	10.3	↗
9:	10.3	←
10:	10.3	↘
Serie		95.0
Total		95.0

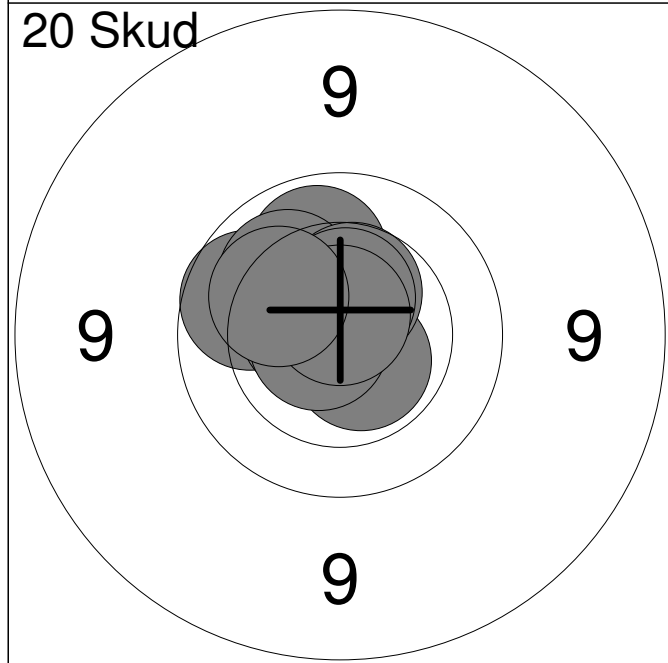

11:	10.1	↗
12:	10.6x	↘
13:	9.9	↗
14:	10.6x	↗
15:	10.1	↗
16:	10.7x	←
17:	10.5	↗
18:	10.5x	↗
19:	10.7x	↗
20:	10.2	↖
Serie		99.0
Total		194.0

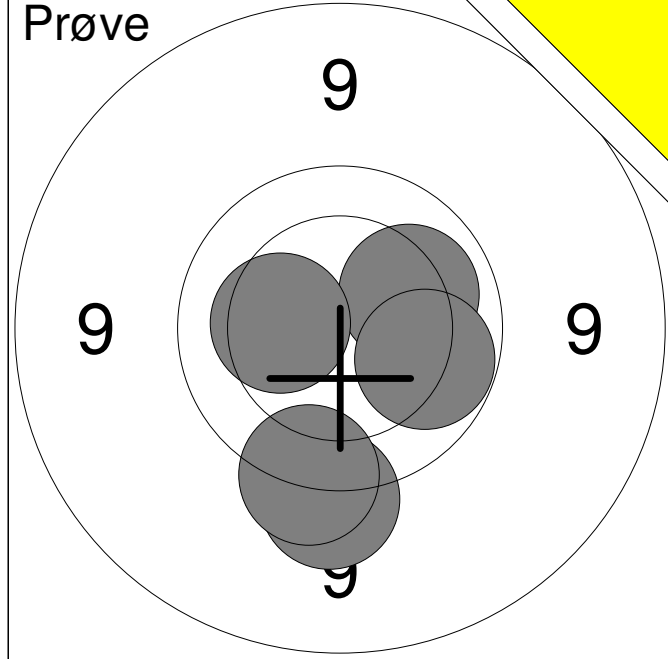

1:	10.1	↗
2:	9.5	↓
3:	9.6	↓
4:	10.3	←
5:	10.0	↘
Serie		48.0
Total		0.0

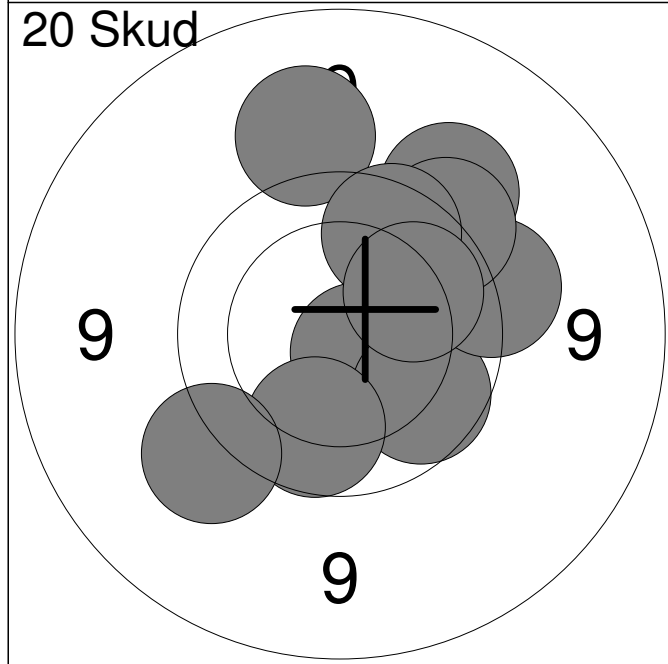

1:	9.3	↑
2:	9.4	↗
3:	10.7x	↓
4:	9.9	↓
5:	9.5	↗
6:	9.6	↗
7:	9.9	↓
8:	9.4	↖
9:	9.8	↑
10:	10.0	↗
Serie		92.0
Total		92.0

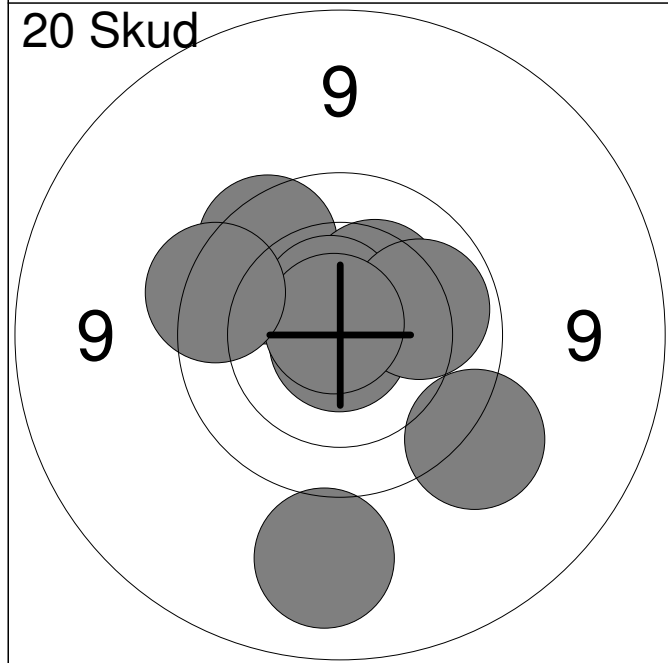

11:	9.5	↓
12:	9.9	↗
13:	9.8	↗
14:	10.3	↗
15:	10.9x	↓
16:	9.1	↓
17:	10.6x	↗
18:	10.0	↗
19:	10.8x	↗
20:	9.7	←
Serie		95.0
Total		187.0

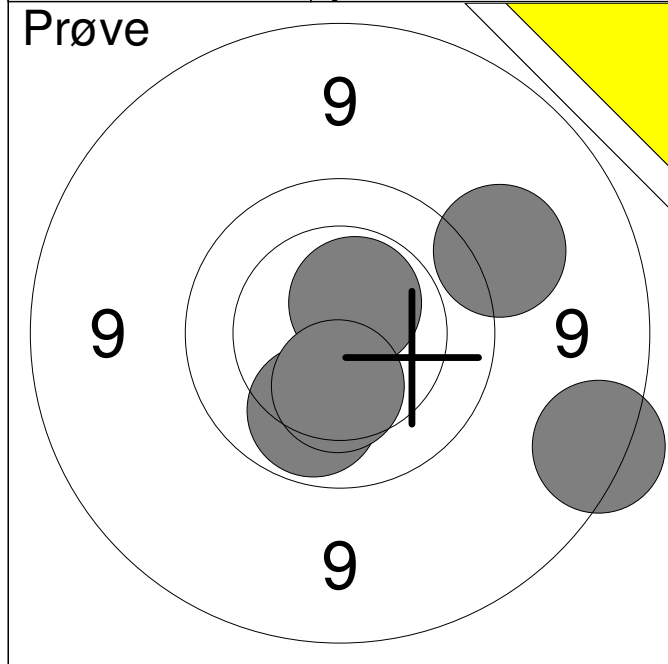

1:	10.6x	↗
2:	9.4	→
3:	8.8	→
4:	10.0	↓
5:	10.4	↓
<b>Serie</b>		<b>47.0</b>
<b>Total</b>		<b>0.0</b>

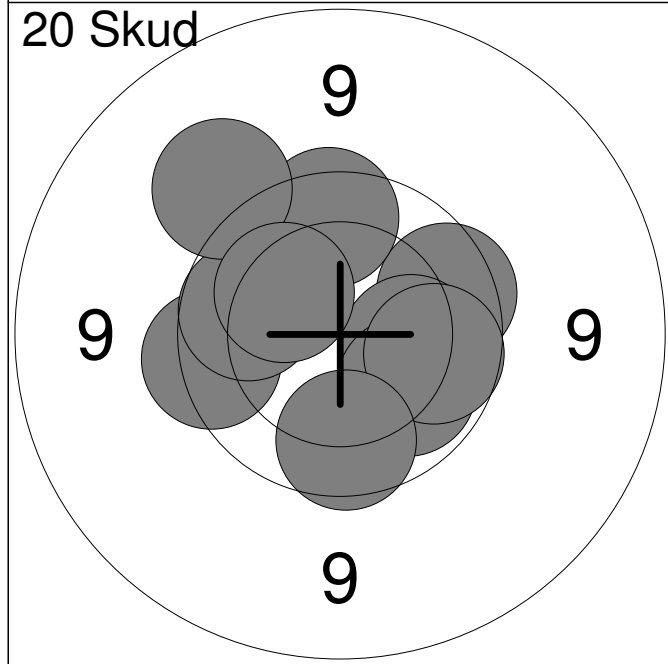

1:	9.7	←
2:	9.9	←
3:	9.8	→
4:	10.2	→
5:	10.0	↓
6:	9.8	↑
7:	9.9	→
8:	9.9	↓
9:	9.4	↗
10:	10.2	↗
<b>Serie</b>		<b>93.0</b>
<b>Total</b>		<b>93.0</b>

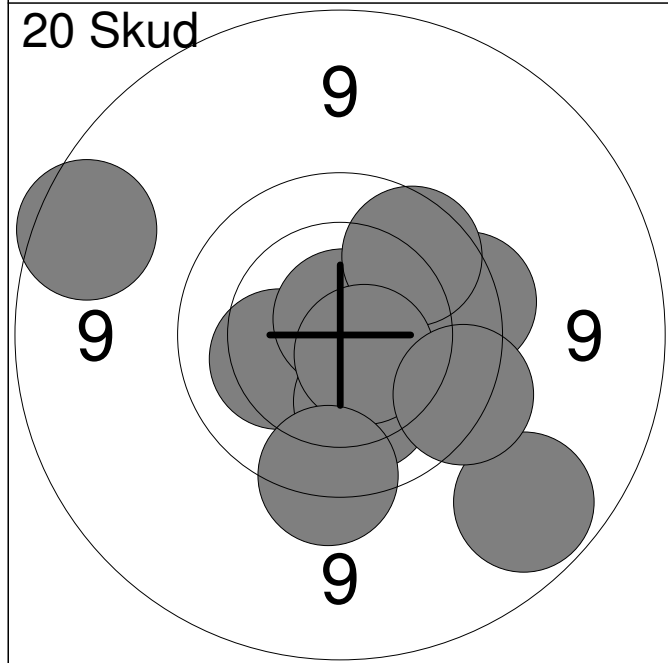

11:	10.2	←
12:	8.9	←
13:	9.0	↓
14:	9.7	→
15:	10.8x	↑
16:	9.9	↗
17:	10.2	↓
18:	10.6x	↓
19:	9.6	↓
20:	9.7	↘
<b>Serie</b>		<b>93.0</b>
<b>Total</b>		<b>186.0</b>

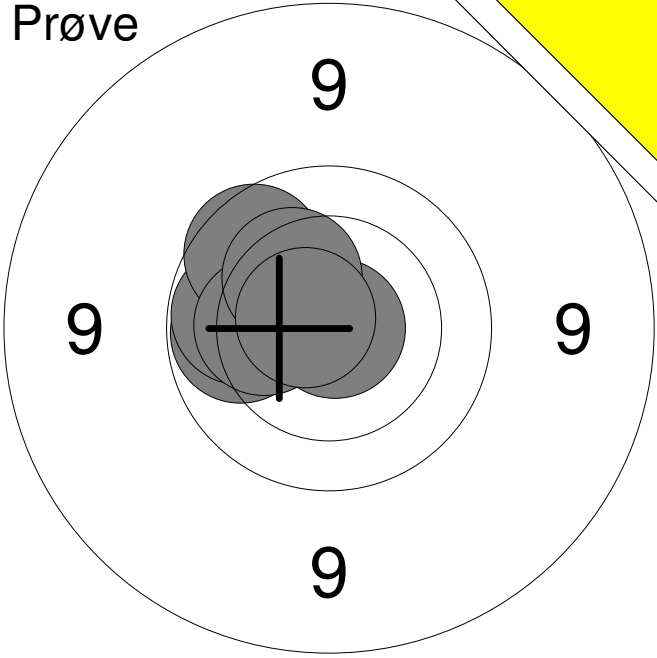
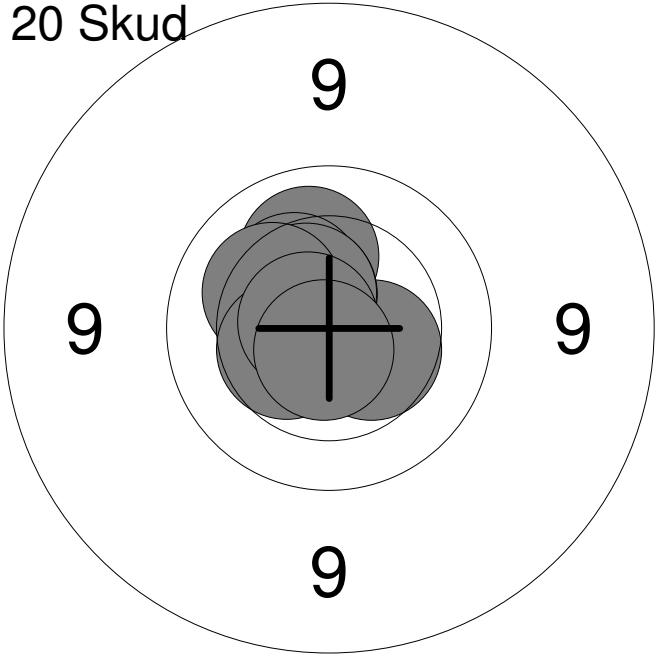
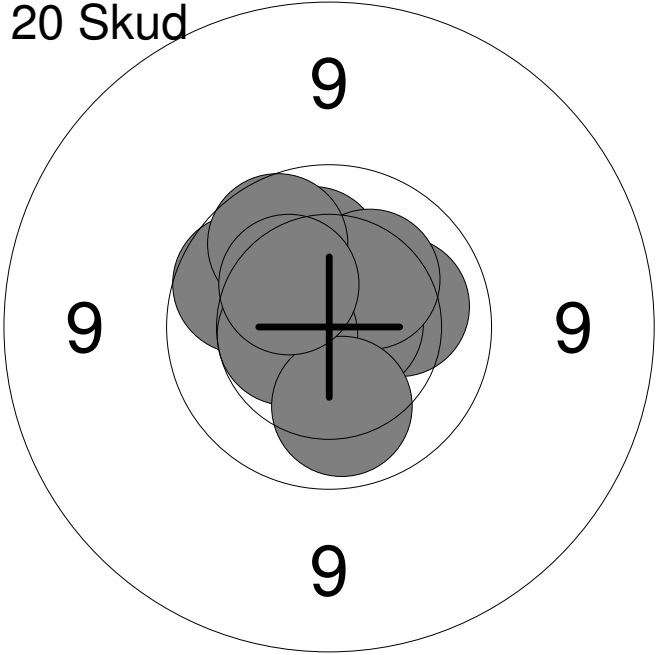
Hold	Skive	Johnni Hald	
AAS		Hobro Egnens Skytteforening	MVÅ2
		Jyllandsstævne 2016	Aalborg Skyttekreds
Prøve		1: 10.9x →	
		2: 10.0 ←	
		3: 10.0 ←	
		4: 9.9 ↗	
		5: 10.2 ←	
		6: 10.3 ↗	
		7: 10.7x ↗	
		Serie	69.0
		Total	0.0
20 Skud		1: 10.1 ↗	
		2: 10.6x ↗	
		3: 10.4 ↘	
		4: 10.5x ↗	
		5: 10.3 ↗	
		6: 10.5x ↗	
		7: 10.2 ↗	
		8: 10.4 ←	
		9: 10.7x ←	
		10: 10.7x ↘	
		Serie	100.0
		Total	100.0
20 Skud		11: 10.2 ↑	
		12: 10.2 →	
		13: 10.8x ↘	
		14: 10.7x →	
		15: 10.3 ↗	
		16: 9.9 ↗	
		17: 10.5x ←	
		18: 10.1 ↘	
		19: 9.9 ↗	
		20: 10.3 ↗	
		Serie	98.0
		Total	198.0

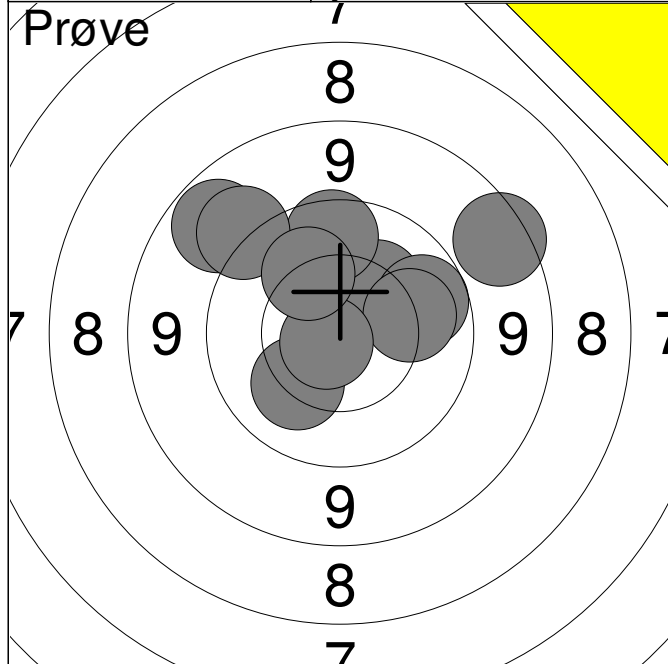

1:	8.7	↗
2:	10.3	↗
3:	9.9	→
4:	9.8	↑
5:	10.2	↘
6:	10.1	→
7:	9.0	↗
8:	9.3	↗
9:	10.8x	↙
10:	10.2	↑
Serie		94.0
Total		0.0

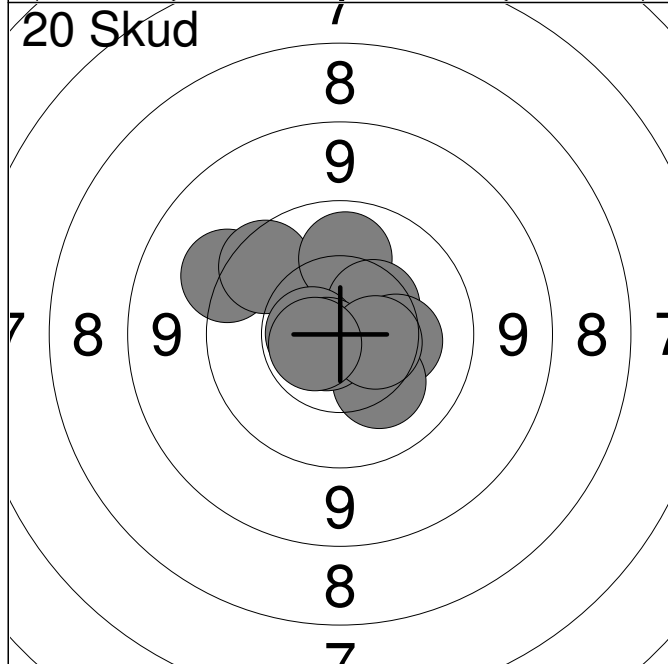

1:	9.4	↖
2:	9.8	↗
3:	10.1	↑
4:	10.4	↗
5:	10.3	→
6:	10.6x	←
7:	10.2	↘
8:	10.8x	↙
9:	10.5	→
10:	10.6x	↙
Serie		98.0
Total		98.0

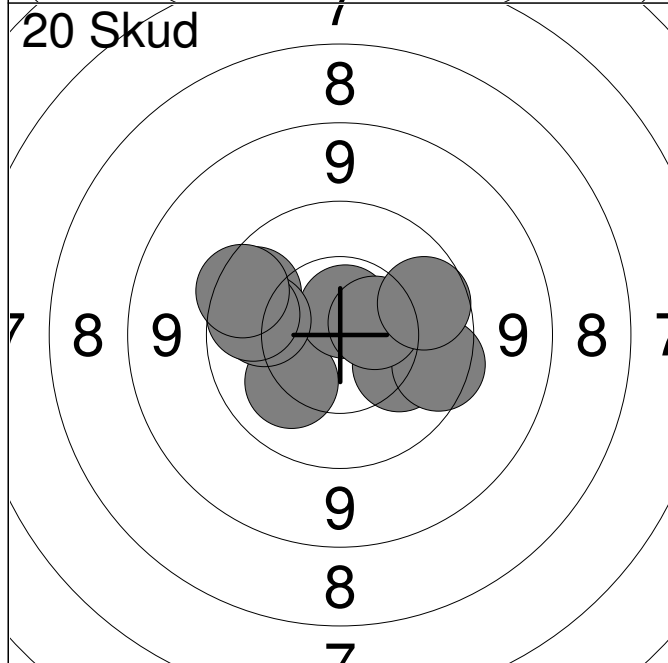

11:	10.2	↙
12:	10.2	→
13:	10.7x	↑
14:	9.8	↗
15:	10.1	←
16:	9.9	←
17:	9.7	→
18:	10.5	→
19:	9.9	→
20:	9.7	↖
Serie		95.0
Total		193.0



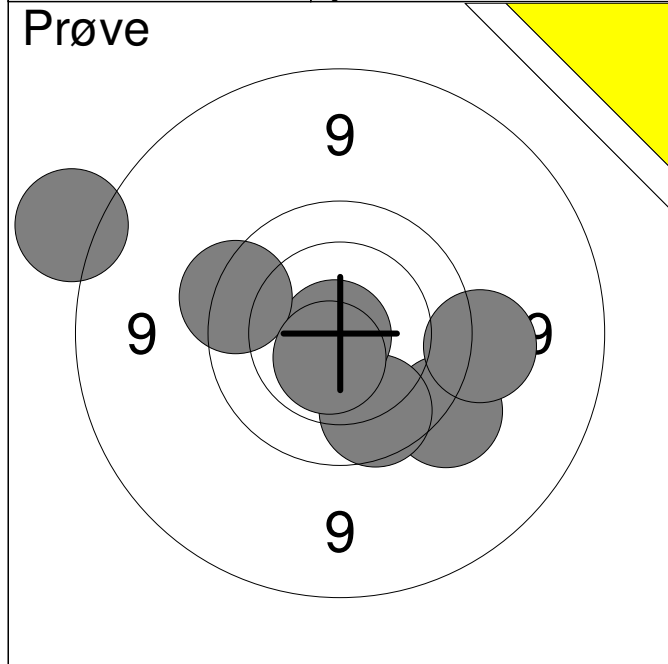

1:	9.5	↘
2:	9.5	→
3:	9.9	↘
4:	8.5	↗
5:	10.9x	↙
6:	9.7	↖
7:	10.6x	↘
<b>Serie</b>		<b>64.0</b>
<b>Total</b>		<b>0.0</b>

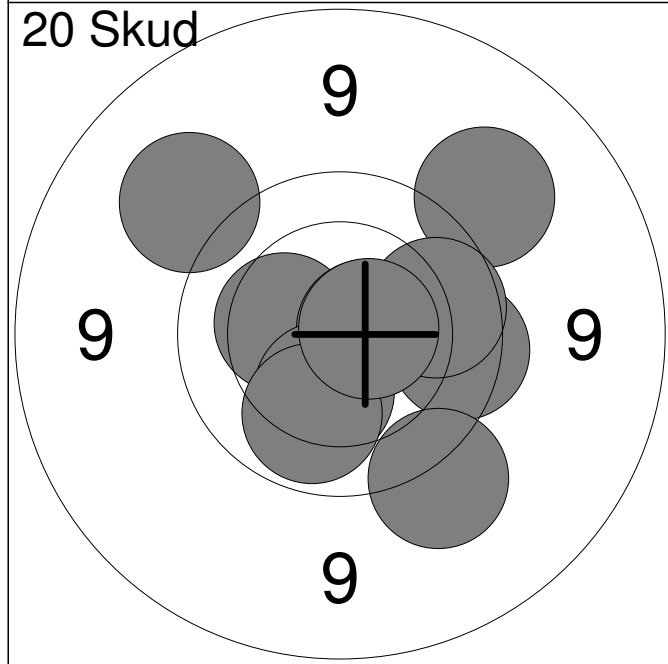

1:	9.3	↗
2:	9.3	↗
3:	9.8	→
4:	9.9	→
5:	10.3	↖
6:	10.7x	→
7:	10.3	↘
8:	10.0	↘
9:	9.4	↘
10:	10.6x	→
<b>Serie</b>		<b>95.0</b>
<b>Total</b>		<b>95.0</b>

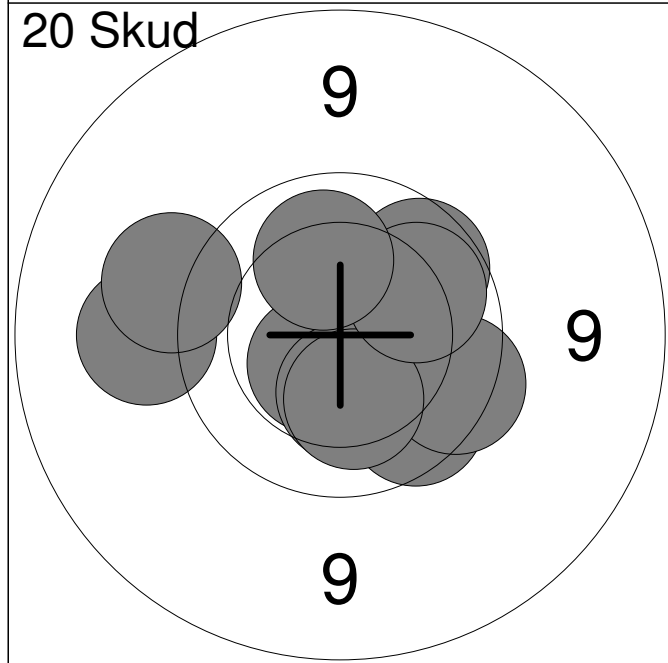

11:	9.3	↖
12:	9.8	↘
13:	10.6x	↘
14:	9.9	↗
15:	9.7	→
16:	10.3	↘
17:	10.2	↘
18:	10.0	↗
19:	9.4	↖
20:	10.1	↗
<b>Serie</b>		<b>95.0</b>
<b>Total</b>		<b>190.0</b>

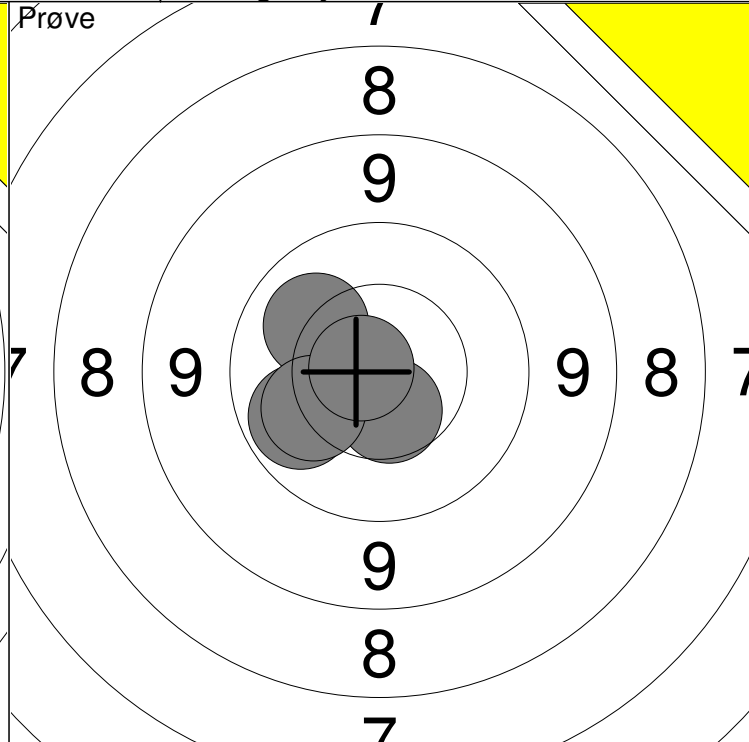
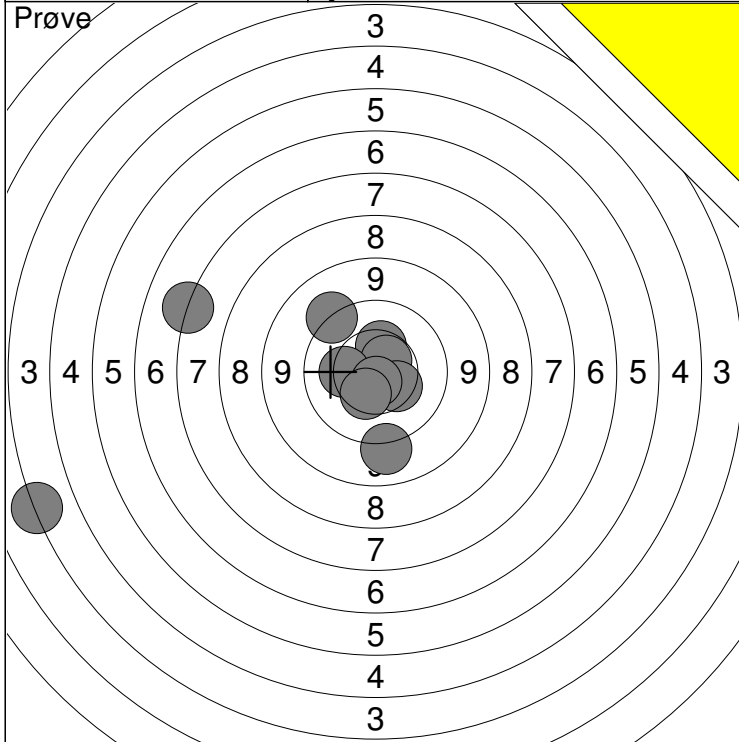

1: 2.4 ←	6: 9.2 ↓	Serie	86
2: 6.4 ←	7: 10.4 ↘		
3: 9.4 ↗	8: 10.3 ←	Total	0
4: 10.4 ↑	9: 10.7x ↓		
5: 10.6x ↗	10: 10.4 ↓		

11: 10.5 ↓	Serie	50
12: 10.1 ↗		
13: 10.0 ←	Total	0
14: 10.2 ←		
15: 10.8x ←		

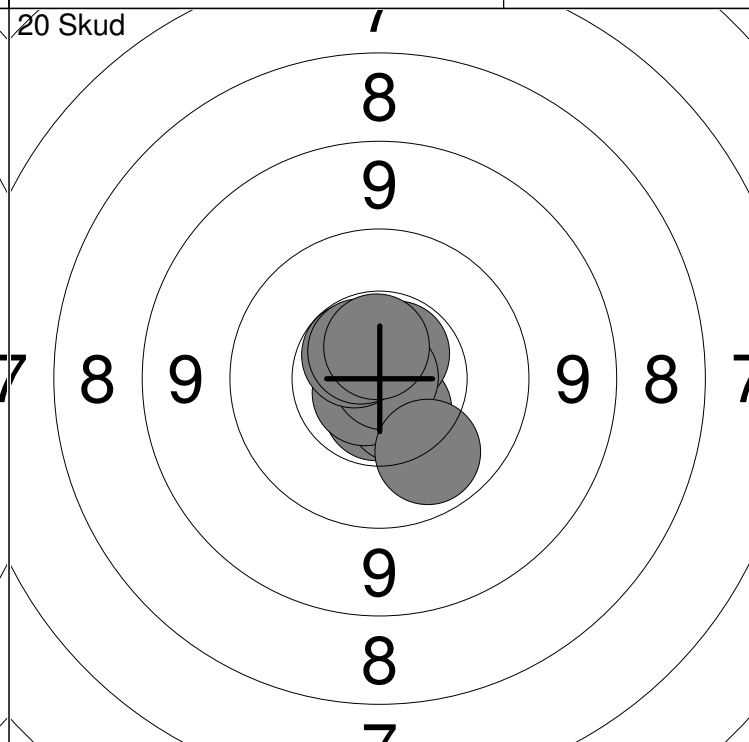
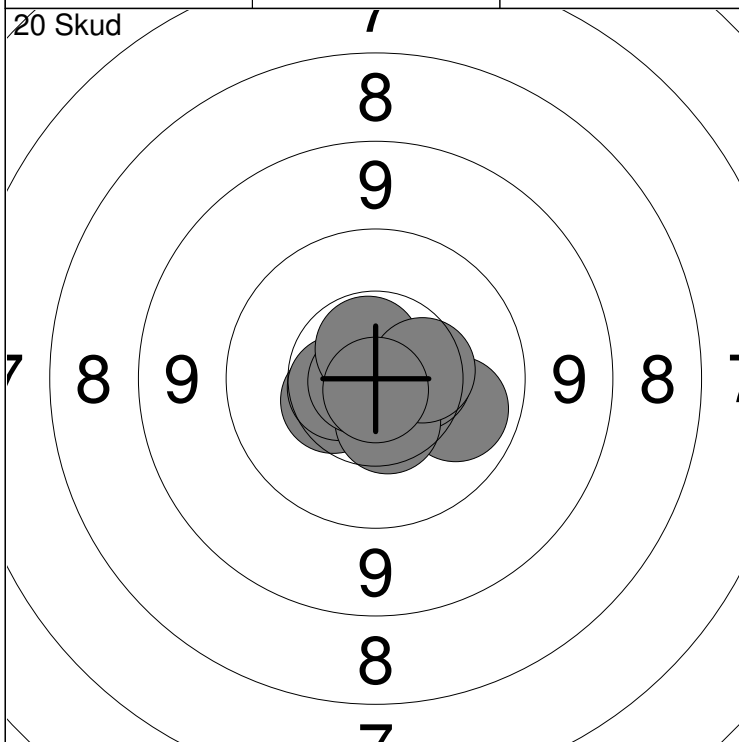

1: 10.5 ←	6: 10.5 ↓	Serie	100
2: 10.6 ←	7: 10.8x ←		
3: 10.6x →	8: 10.6x ↑	Total	100
4: 10.1 →	9: 10.5 →		
5: 10.5 →	10: 10.8x ↓		

11: 10.6x ↓	Serie	100
12: 10.8x ↗		
13: 10.6 ↓	Total	200
14: 10.6x ↗		
15: 10.7x ↘	16: 10.9x →	
	17: 10.6x ↗	
	18: 10.0 ↓	
	19: 10.6x ↗	
	20: 10.6x ↑	

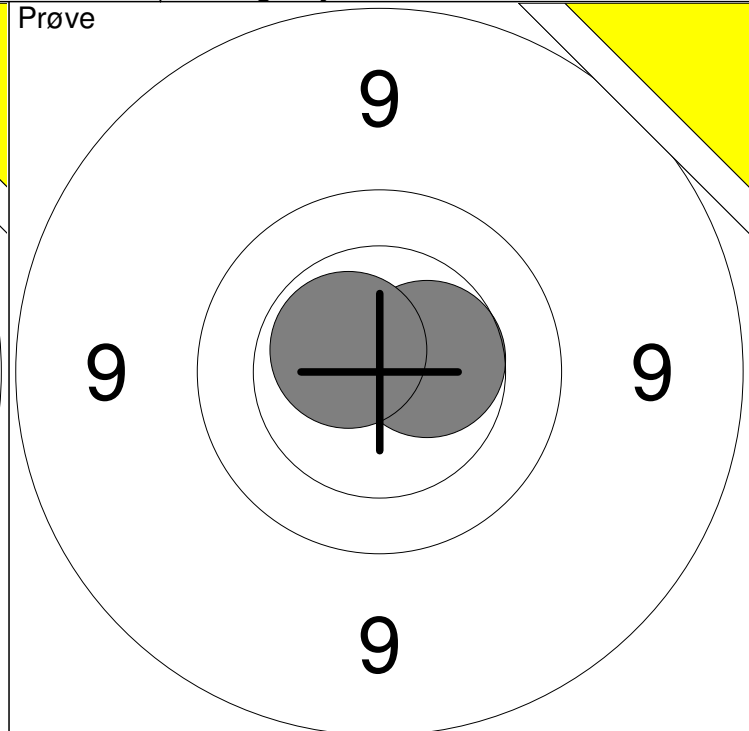
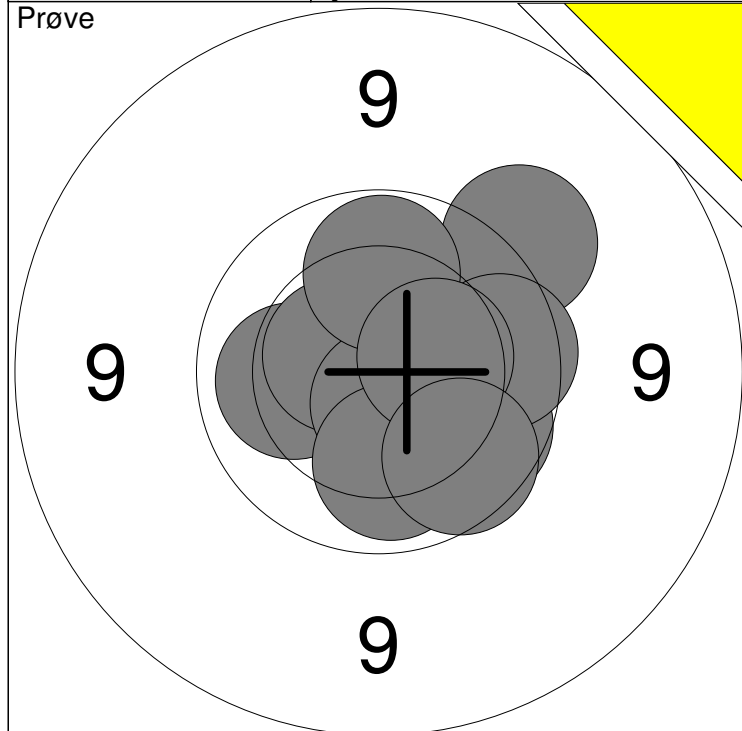

1: 10.1 ←	6: 9.9 →	Serie	96
2: 9.5 ↗	7: 10.0 ↑		
3: 10.6x ↖	8: 9.8 →	Total	0
4: 10.6x ↓	9: 10.4 →		
5: 10.1 ↓	10: 9.9 ↘		

11: 10.5 →	Serie	20
12: 10.6x ↖		
Total		0

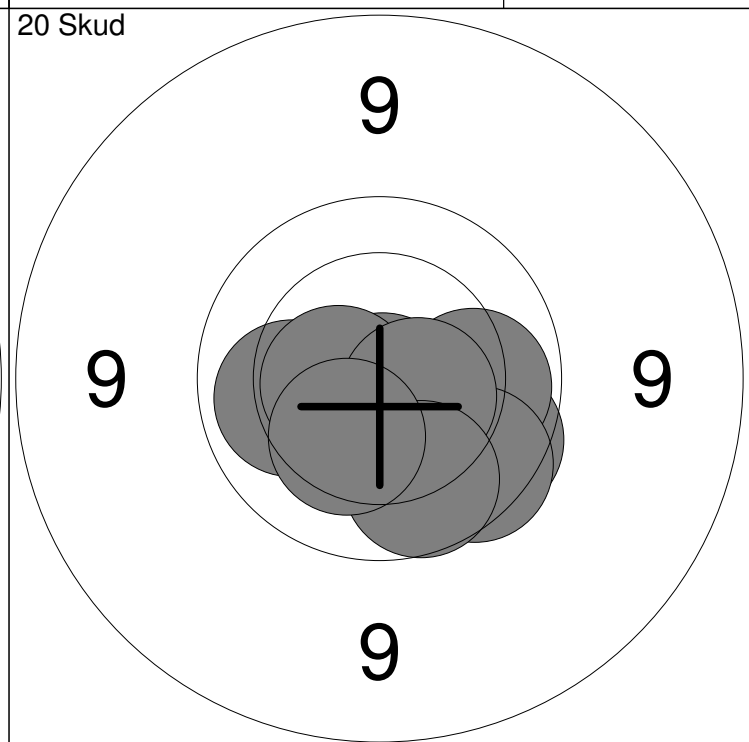
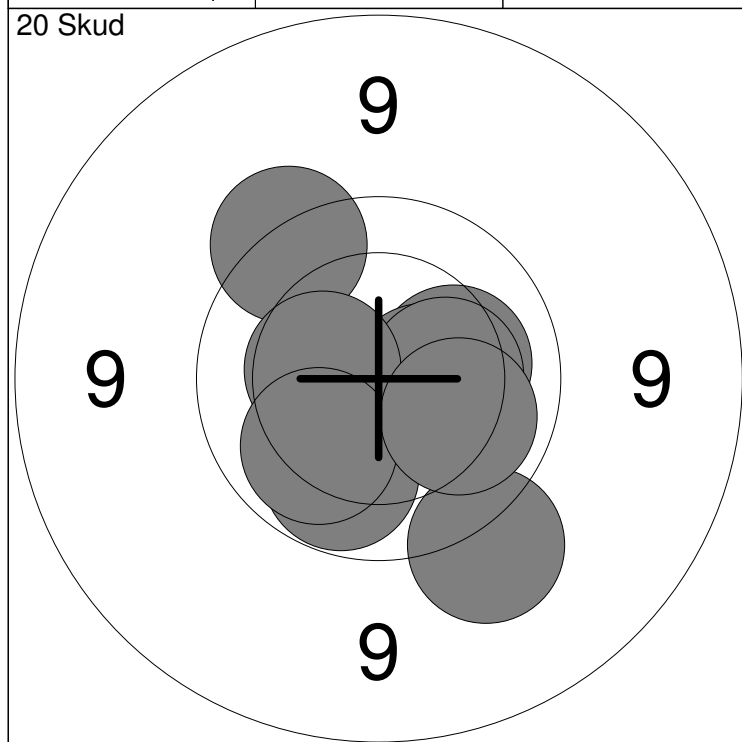

1: 9.4 ↘	6: 10.3 →	Serie	98
2: 10.2 →	7: 10.0 ↓		
3: 10.5x →	8: 10.4 ←	Total	98
4: 9.6 ↗	9: 10.1 ↘		
5: 10.6x ↘	10: 10.1 ↘		

11: 9.8 →	16: 10.6x ←	Serie	97
12: 10.4 ↘	17: 9.8 ↘		
13: 10.8x ↓	18: 10.5x →	Total	195
14: 10.1 ←	19: 9.9 ↘		
15: 10.0 →	20: 10.3 ↘		

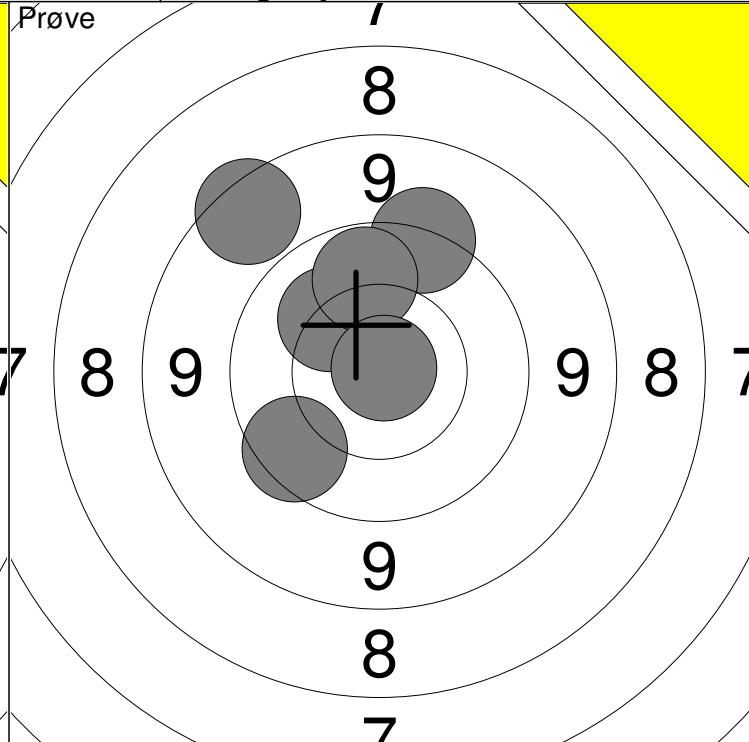
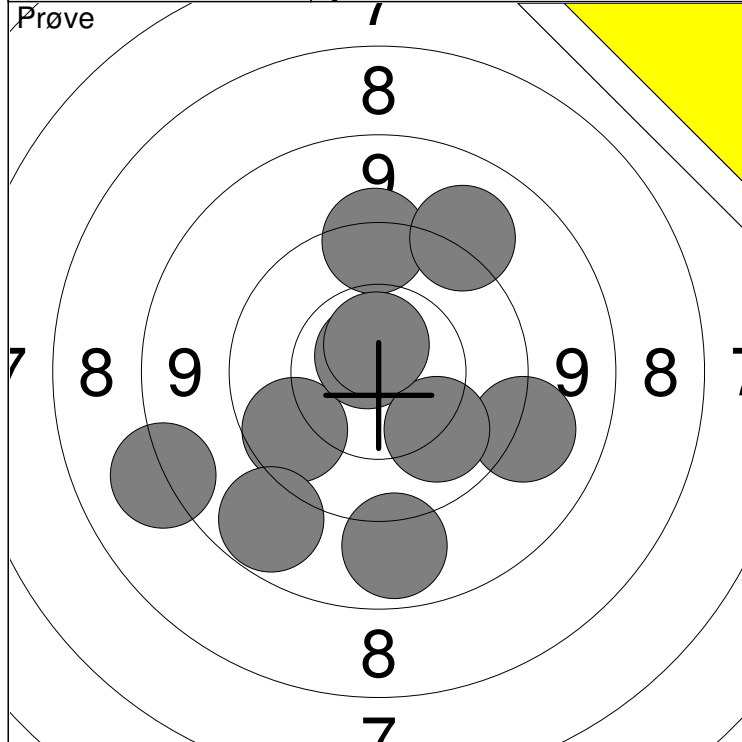

1: 9.6 ↑	6: 9.3 →	Serie 92
2: 8.3 ↙	7: 10.7x ↗	
3: 9.9 ↙	8: 10.1 ↘	Total 0
4: 9.1 ↓	9: 9.3 ↗	
5: 9.0 ↘	10: 10.7x ↑	

11: 9.5 ↗	16: 10.9x ↗	Serie 56
12: 10.2 ↗	13: 8.7 ↗	
13: 8.7 ↗	14: 9.7 ↙	Total 0
14: 9.7 ↙	15: 10.0 ↑	

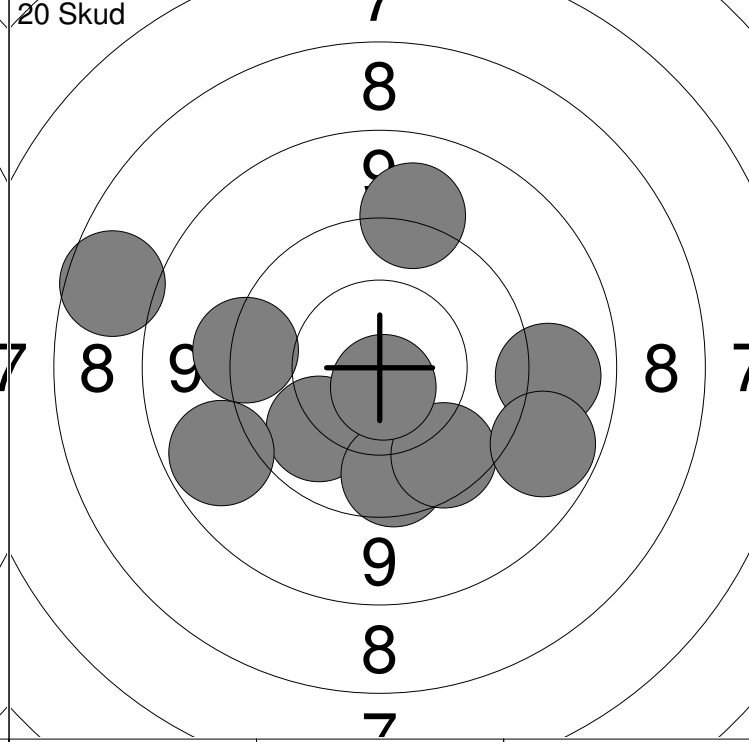
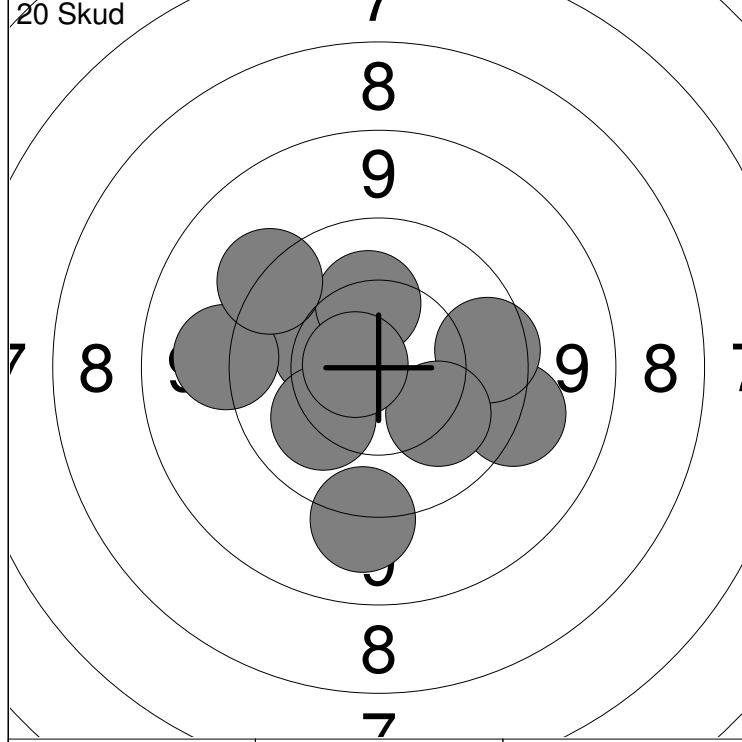

1: 9.3 ↓	6: 9.3 ←	Serie 95
2: 9.4 →	7: 10.2 ↘	
3: 10.4 ↙	8: 10.3 ↑	Total 95
4: 10.2 ↙	9: 10.7x ←	
5: 9.8 →	10: 9.5 ↗	

11: 9.3 ↑	16: 9.0 ↙	Serie 90
12: 7.9 ↙	17: 9.8 ↘	
13: 9.1 →	18: 9.0 ↘	Total 185
14: 10.1 ↙	19: 9.5 ←	
15: 9.8 ↓	20: 10.7x ↓	

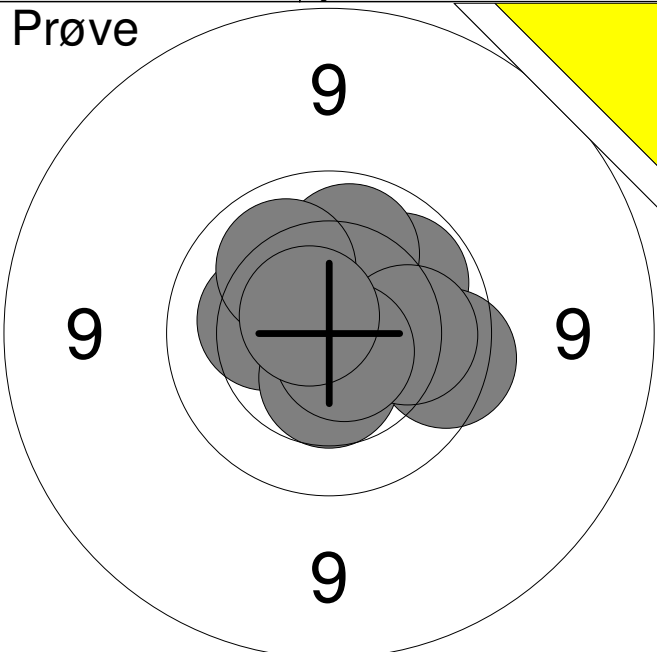
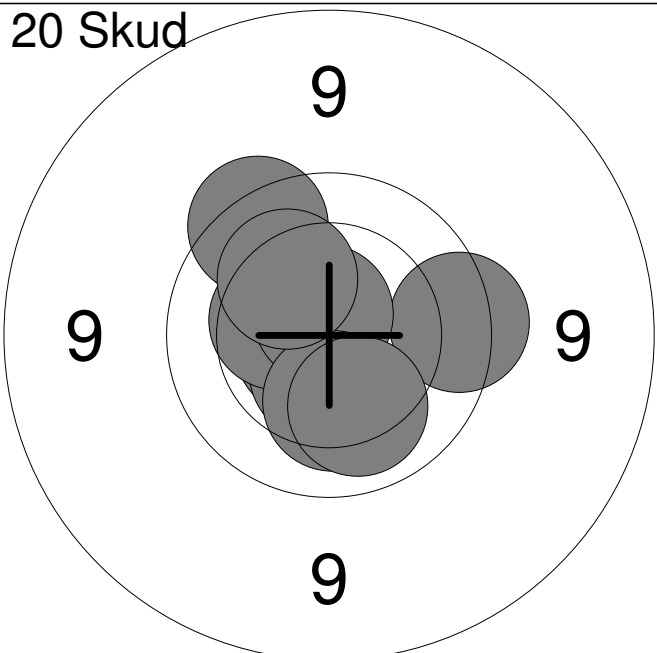
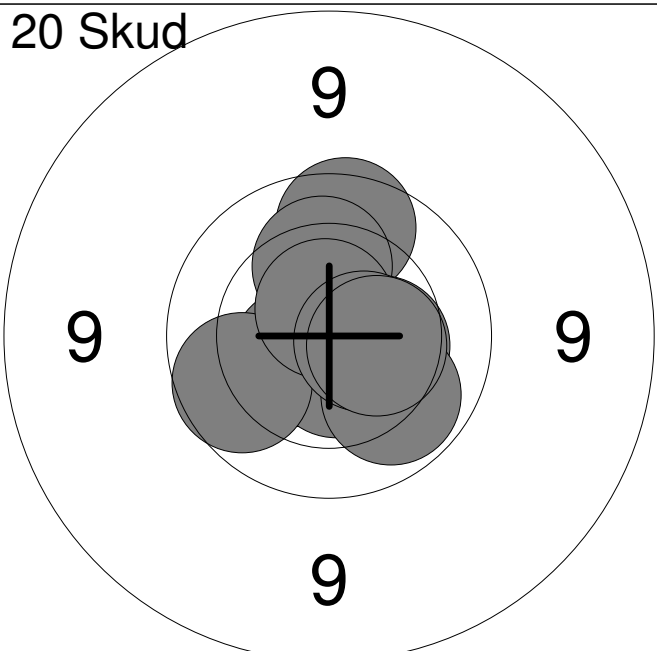
Hold	Skive	Bent Andersen	
AAS	Vodskov Skytteforening	MVÅ1	
Jyllandsstævne 2016		Aalborg Skyttekreds	
<b>Prøve</b> 	1:	10.0	↗
	2:	10.6x	↓
	3:	9.8	→
	4:	10.3	←
	5:	10.5	↓
	6:	10.1	↑
	7:	10.1	→
	8:	10.7x	↘
	9:	10.1	↗
	10:	10.7x	↗
	Serie		99.0
Total		0.0	
<b>20 Skud</b> 	1:	10.7x	↗
	2:	10.7x	←
	3:	9.7	→
	4:	10.5x	↓
	5:	10.4	←
	6:	10.7x	↑
	7:	10.2	↓
	8:	10.1	↘
	9:	9.7	↗
	10:	10.2	↗
	Serie		98.0
Total		98.0	
<b>20 Skud</b> 	11:	9.8	↑
	12:	10.6x	↖
	13:	10.2	↑
	14:	10.4	→
	15:	10.6x	↓
	16:	10.0	↘
	17:	9.9	↖
	18:	10.7x	↑
	19:	10.6x	→
	20:	10.4	→
	Serie		98.0
Total		196.0	

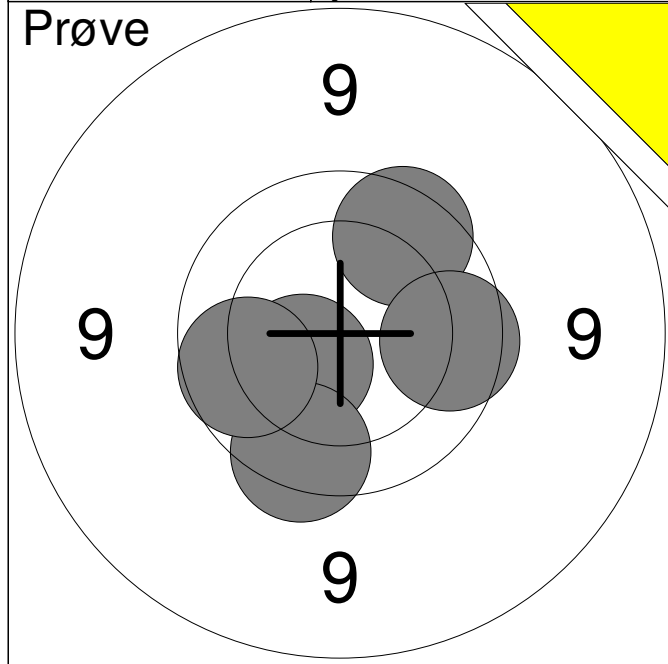

1:	10.4	↙
2:	9.7	↓
3:	9.8	↗
4:	9.8	→
5:	9.9	↖
Serie		46.0
Total		0.0

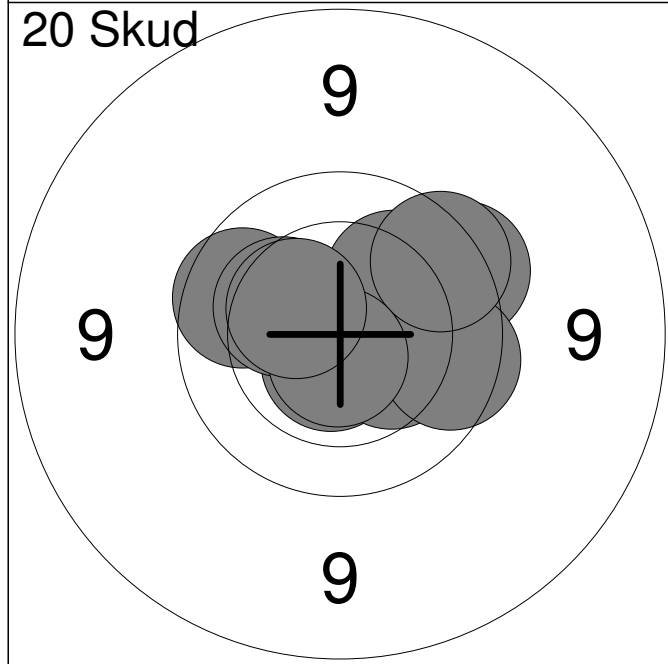

1:	10.6x	↓
2:	9.9	↖
3:	10.3	↖
4:	10.3	→
5:	9.7	↗
6:	10.1	↗
7:	9.8	→
8:	9.8	↗
9:	10.7x	↓
10:	10.4	↖
Serie		96.0
Total		96.0

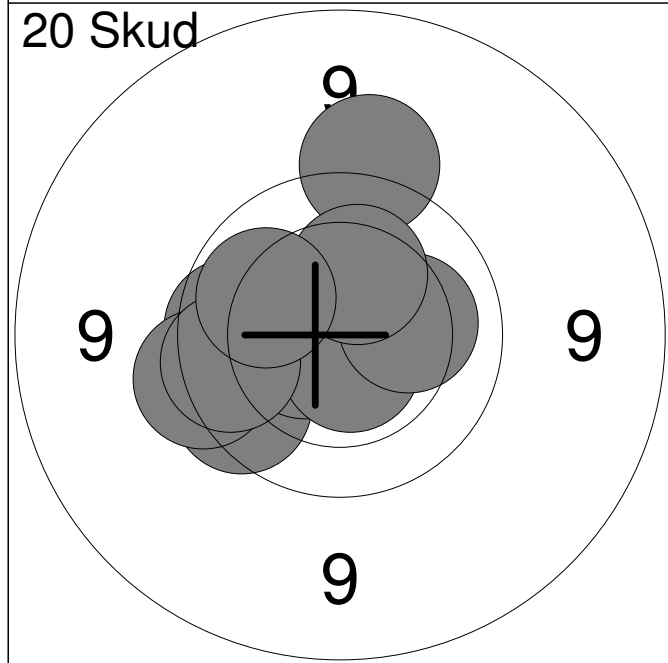

11:	9.5	↑
12:	9.8	↖
13:	9.9	↖
14:	10.5x	↖
15:	10.6x	↓
16:	9.6	↖
17:	10.2	→
18:	9.8	↖
19:	10.3	↗
20:	10.1	↖
Serie		95.0
Total		191.0

Hold <b>12</b>	Skive <b>4</b>	<b>Daniel Mørk</b>		
AAS		Hobro Egnens Skytteforening		UÅ1
		Jyllandsstævne 2016	Aalborg Skyttekreds	
Prøve		1:	10.2	↓
		2:	10.3	↓
		3:	10.5x	↓
		4:	10.4	↗
		5:	9.9	↖
		6:	10.6x	↑
		Serie	59.0	
		Total	0.0	
20 Skud		1:	10.6x	↓
		2:	10.0	←
		3:	10.2	←
		4:	10.4	←
		5:	10.2	↓
		6:	10.7x	↗
		7:	10.0	↖
		8:	10.2	→
		9:	10.0	↓
		10:	10.4	→
		Serie	100.0	
		Total	100.0	
20 Skud		11:	10.4	↑
		12:	10.0	→
		13:	10.3	↑
		14:	10.5	→
		15:	10.6x	↗
		16:	10.6x	↖
		17:	10.6x	↗
		18:	10.5x	↓
		19:	10.0	→
		20:	10.6x	↑
		Serie	100.0	
		Total	200.0	

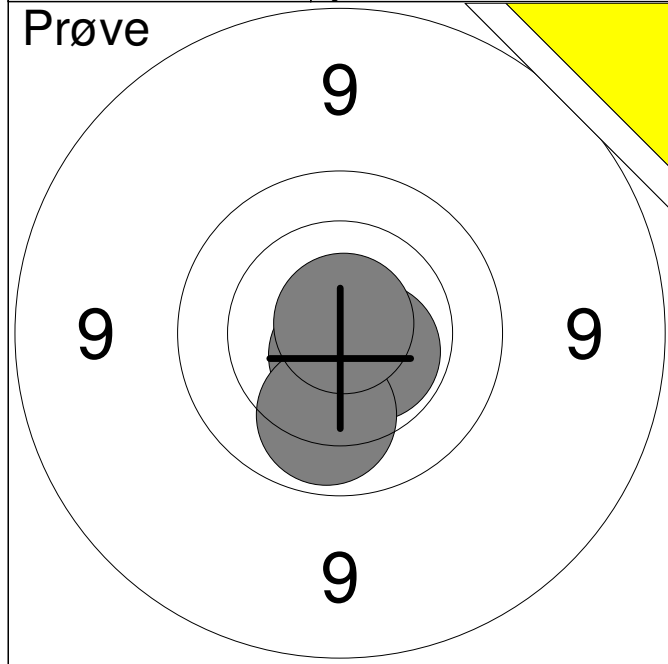

1:	10.7x	↓
2:	10.6x	→
3:	10.1	↓
4:	10.8x	↑
<b>Serie</b>		<b>40.0</b>
<b>Total</b>		<b>0.0</b>

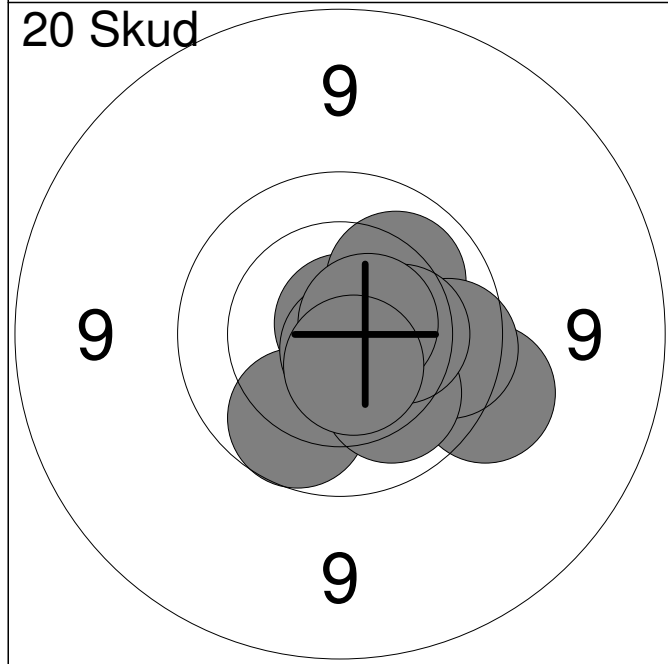

1:	9.9	↓
2:	9.6	→
3:	10.8x	↑
4:	10.1	↗
5:	9.8	→
6:	10.8x	↓
7:	10.1	↓
8:	10.3	→
9:	10.6x	↗
10:	10.6x	↓
<b>Serie</b>		<b>97.0</b>
<b>Total</b>		<b>97.0</b>

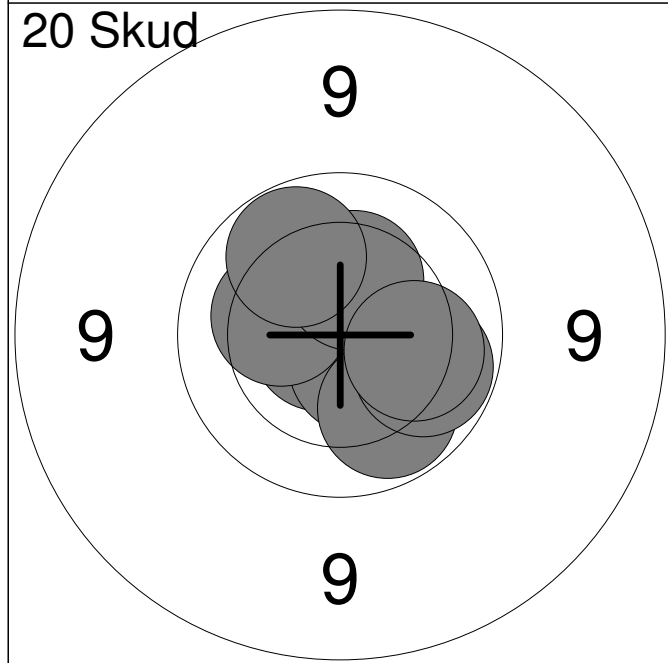

11:	10.5	↗
12:	10.7x	←
13:	10.5	↓
14:	10.6x	↓
15:	10.0	↓
16:	10.3	↗
17:	10.0	→
18:	10.3	↑
19:	10.0	↗
20:	10.1	→
<b>Serie</b>		<b>100.0</b>
<b>Total</b>		<b>197.0</b>



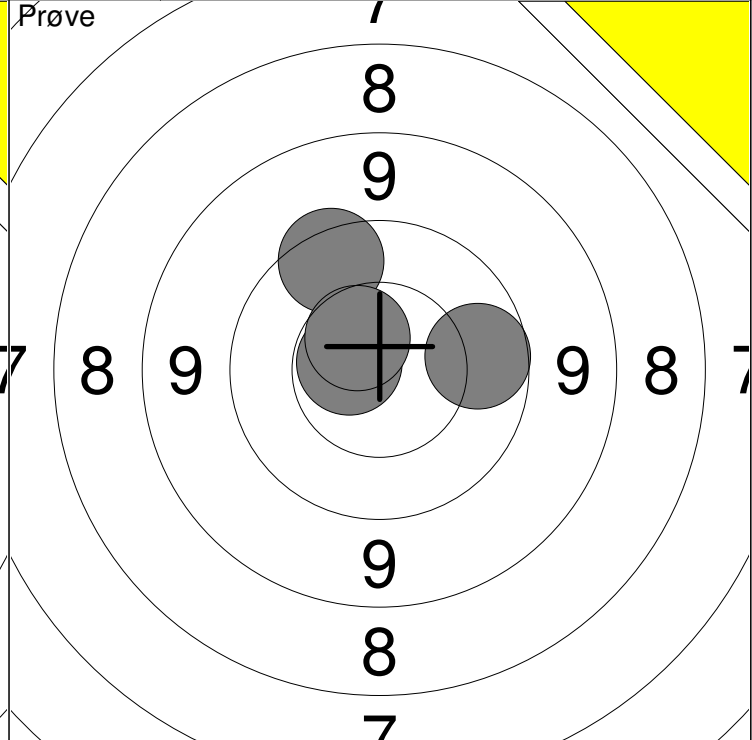
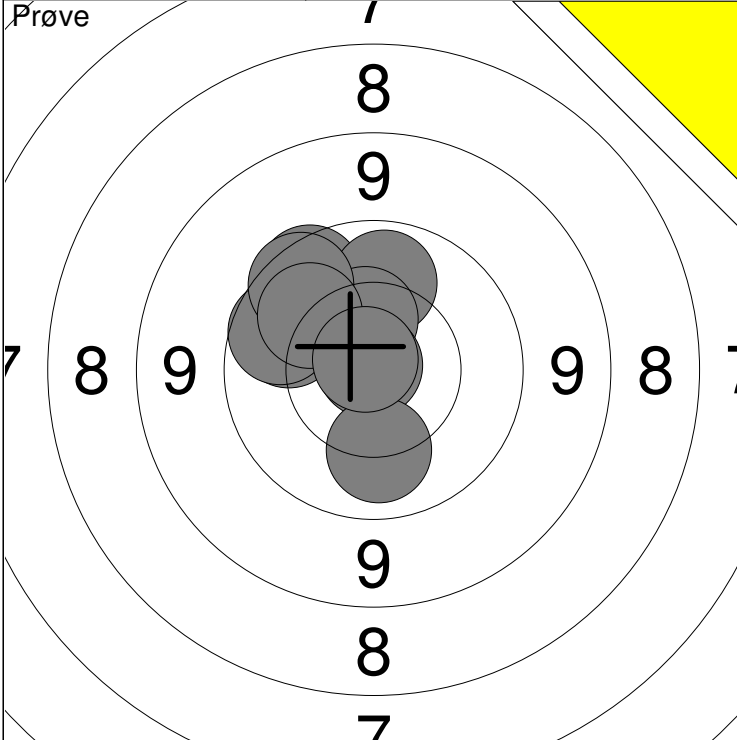

1: 9.8 ↗	6: 10.9x ↗	Serie	97
2: 10.0 ↑	7: 9.8 ↗		
3: 10.0 ↖	8: 10.1 ↗	Total	0
4: 10.4 ↑	9: 10.1 ↓		
5: 9.9 ↖	10: 10.8x ↗		

11: 9.9 →	Serie	38
12: 10.6x ↖		
13: 9.7 ↗	Total	0
14: 10.5 ↗		

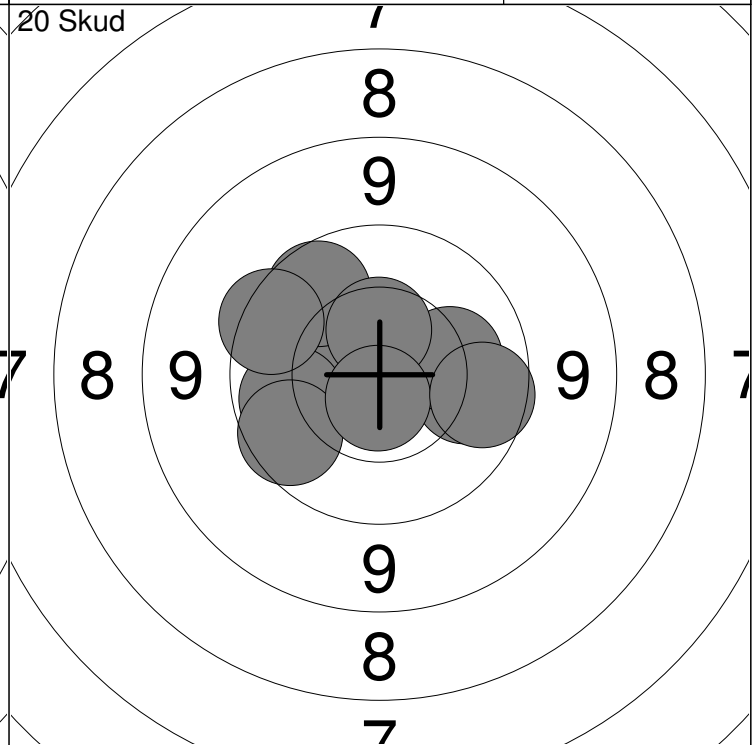
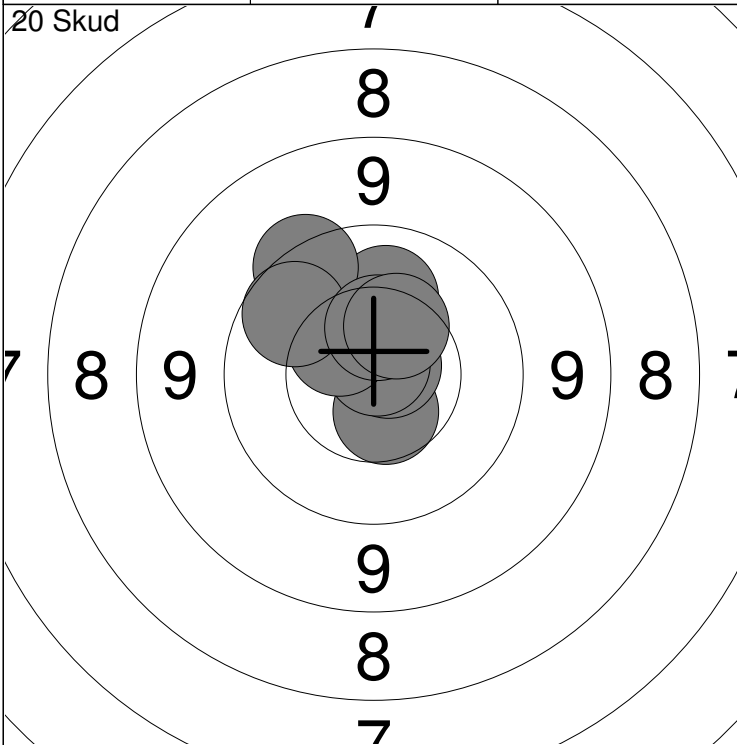

1: 10.5 ↑	6: 10.8x ↗	Serie	98
2: 10.5 ↓	7: 10.5 ↗		
3: 10.2 ↑	8: 9.9 ↖	Total	98
4: 10.8x ↗	9: 10.5 ↑		
5: 9.6 ↖	10: 10.4 ↗		

11: 10.0 →	Serie	96
12: 10.3 ↗		
13: 9.9 ↗	Total	194
14: 10.0 ↖		
15: 10.2 →	16: 9.8 ↖	
	17: 10.5 ↑	
	18: 10.7x ↓	
	19: 9.7 ↖	
	20: 9.9 →	

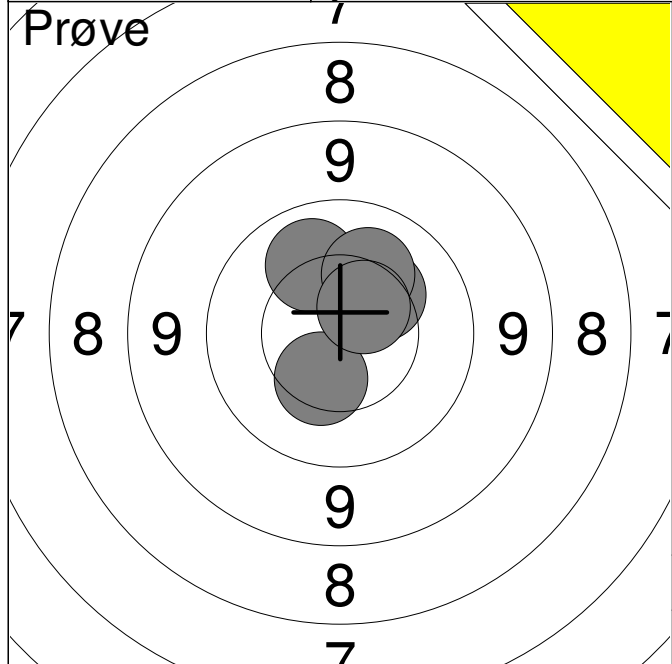

1:	10.1	↑
2:	10.3	↗
3:	10.2	↑
4:	10.4	↓
5:	10.5	↗
<b>Serie</b>		<b>50.0</b>
<b>Total</b>		<b>0.0</b>

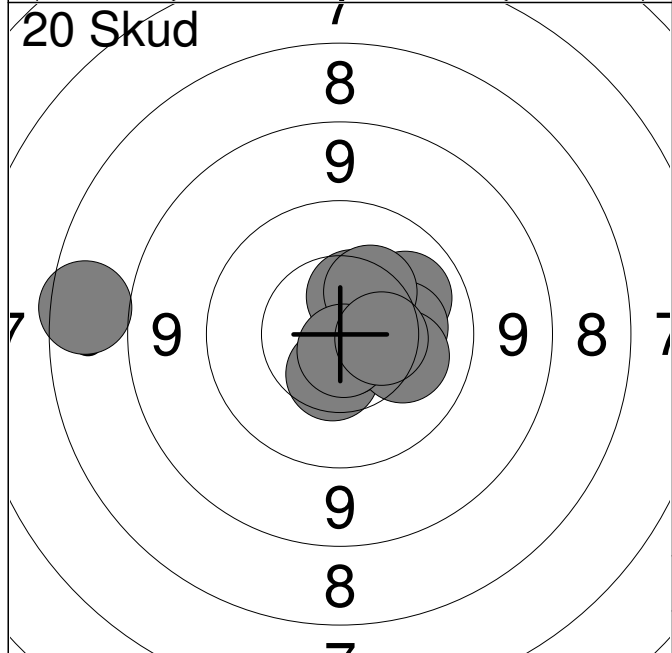

1:	10.1	↗
2:	10.5	↓
3:	10.8x	↓
4:	10.2	→
5:	10.2	→
6:	7.8	←
7:	10.5	↑
8:	10.3	↗
9:	10.8x	↓
10:	10.5	→
<b>Serie</b>		<b>97.0</b>
<b>Total</b>		<b>97.0</b>

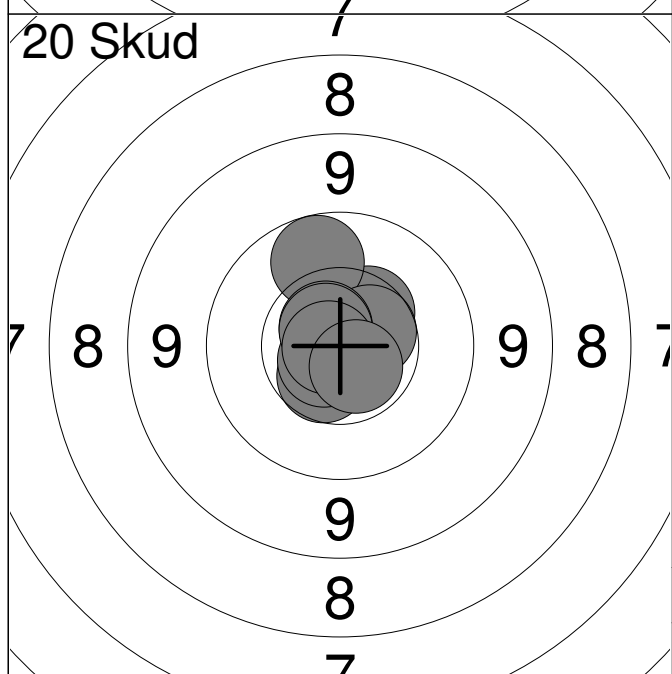

11:	10.4	↗
12:	9.9	↑
13:	10.7x	↓
14:	10.6	↗
15:	10.7x	↗
16:	10.6	↓
17:	10.7x	↖
18:	10.7x	↗
19:	10.8x	←
20:	10.7x	↓
<b>Serie</b>		<b>99.0</b>
<b>Total</b>		<b>196.0</b>

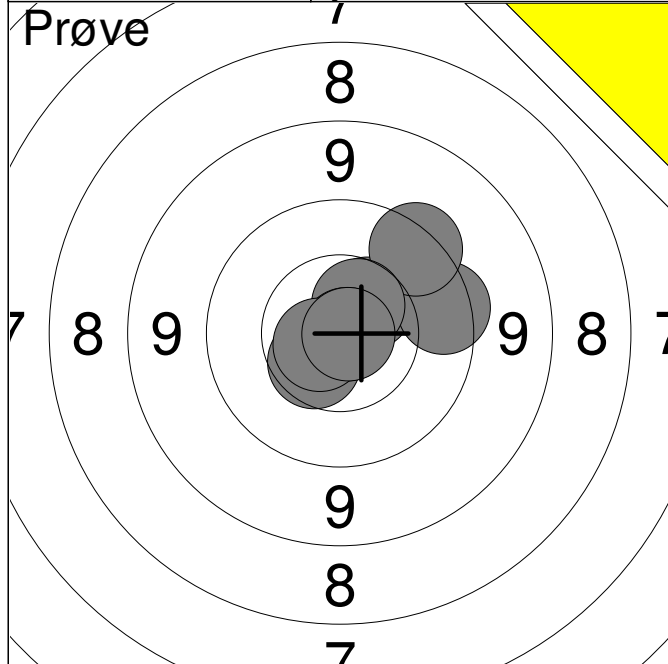

1:	10.5	↗
2:	9.7	→
3:	9.6	↗
4:	10.6	↗
5:	10.5	↙
6:	10.9x	→
7:	10.7x	↙
8:	10.8x	→
<b>Serie</b>		<b>78.0</b>
<b>Total</b>		<b>0.0</b>

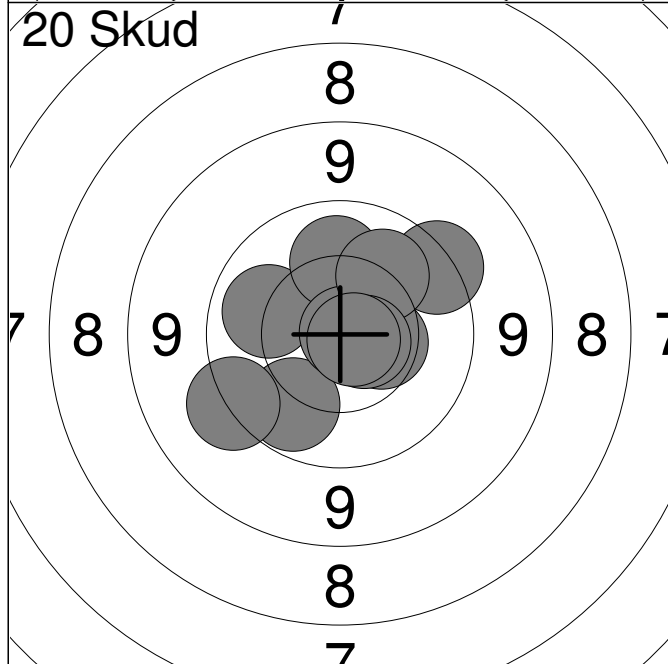

1:	10.5	→
2:	10.0	↙
3:	10.1	↙
4:	9.4	↙
5:	10.1	↑
6:	10.9x	→
7:	9.6	↗
8:	10.1	↗
9:	10.7x	→
10:	10.8x	→
<b>Serie</b>		<b>98.0</b>
<b>Total</b>		<b>98.0</b>

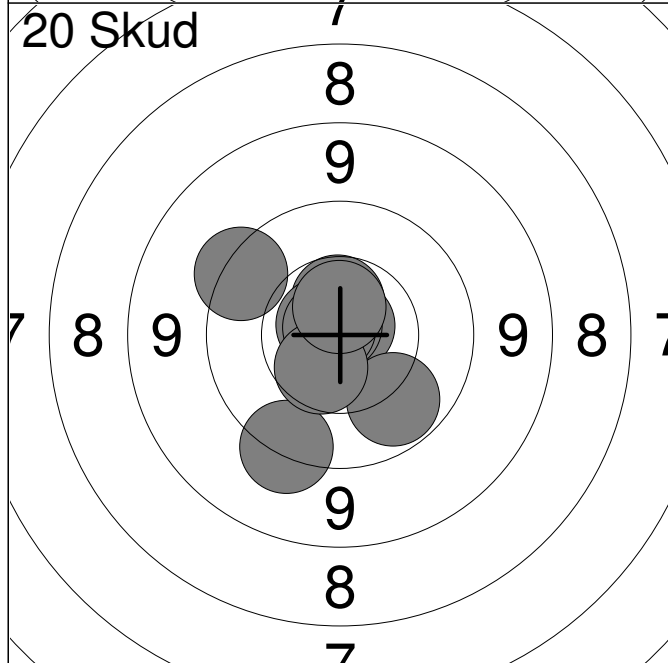

11:	9.5	↙
12:	9.6	↗
13:	10.6	↑
14:	10.8x	↗
15:	10.0	↙
16:	10.7x	↗
17:	10.8x	↗
18:	10.8x	↗
19:	10.5	↙
20:	10.6x	↑
<b>Serie</b>		<b>98.0</b>
<b>Total</b>		<b>196.0</b>

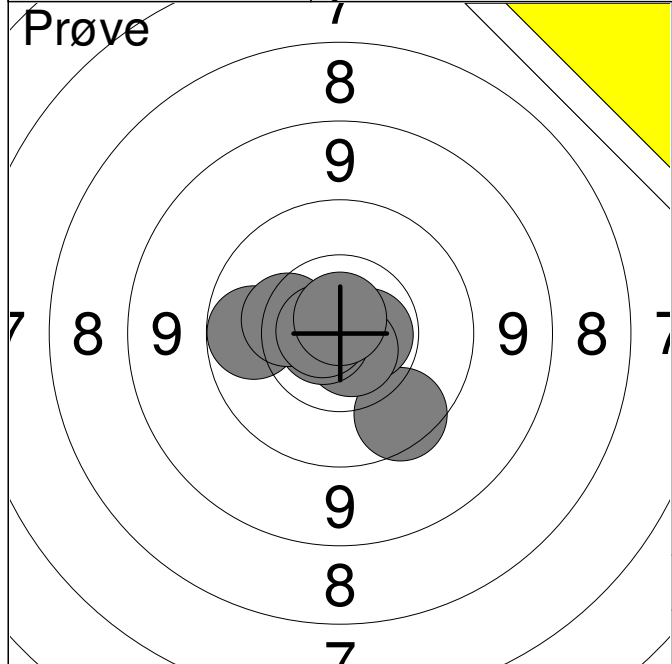

1:	9.8	↘
2:	10.6x	→
3:	10.7x	↘
4:	10.8x	←
5:	10.0	←
6:	10.3	←
7:	10.7x	←
8:	10.8x	↑
<b>Serie</b>		<b>79.0</b>
<b>Total</b>		<b>0.0</b>

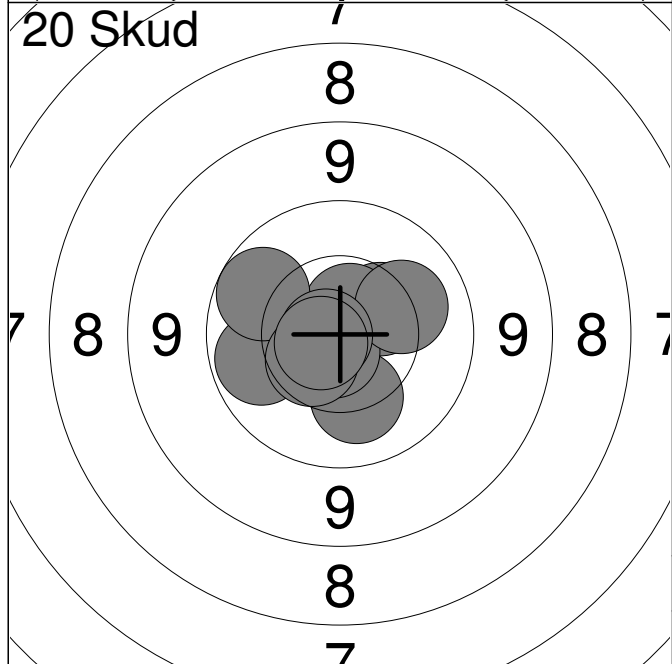

1:	10.0	←
2:	10.4	↗
3:	10.2	↘
4:	10.7x	↑
5:	10.7x	↘
6:	10.2	↗
7:	9.9	↖
8:	10.5	↘
9:	10.8x	←
10:	10.7x	↖
<b>Serie</b>		<b>99.0</b>
<b>Total</b>		<b>99.0</b>

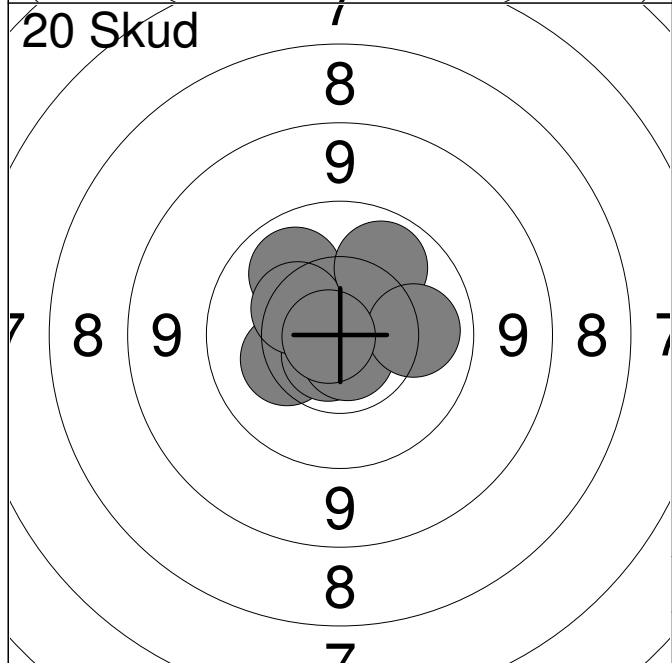

11:	10.3	←
12:	10.7x	↘
13:	10.7x	↗
14:	10.9x	↑
15:	10.1	↗
16:	10.4	↗
17:	10.7x	↘
18:	10.0	↗
19:	10.1	→
20:	10.8x	←
<b>Serie</b>		<b>100.0</b>
<b>Total</b>		<b>199.0</b>

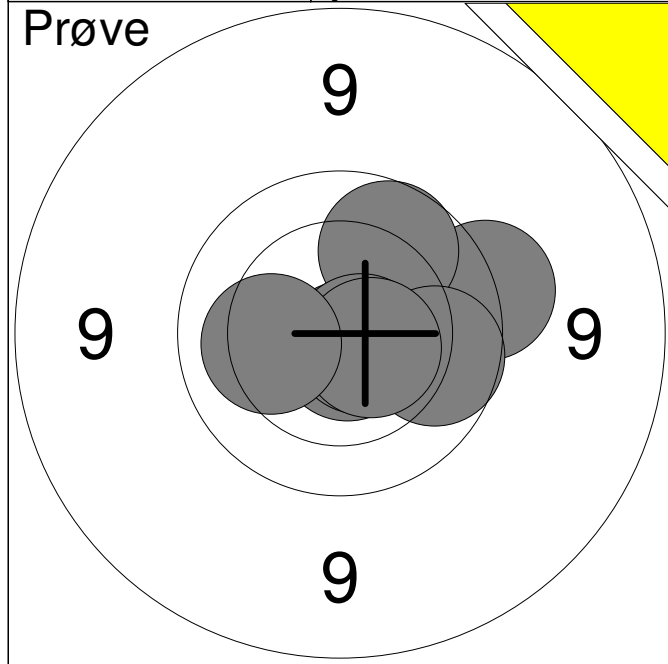

1:	9.6	→
2:	9.9	↗
3:	10.7x	↓
4:	10.7x	↘
5:	9.9	→
6:	10.6x	↘
7:	10.2	←
<b>Serie</b>		<b>67.0</b>
<b>Total</b>		<b>0.0</b>

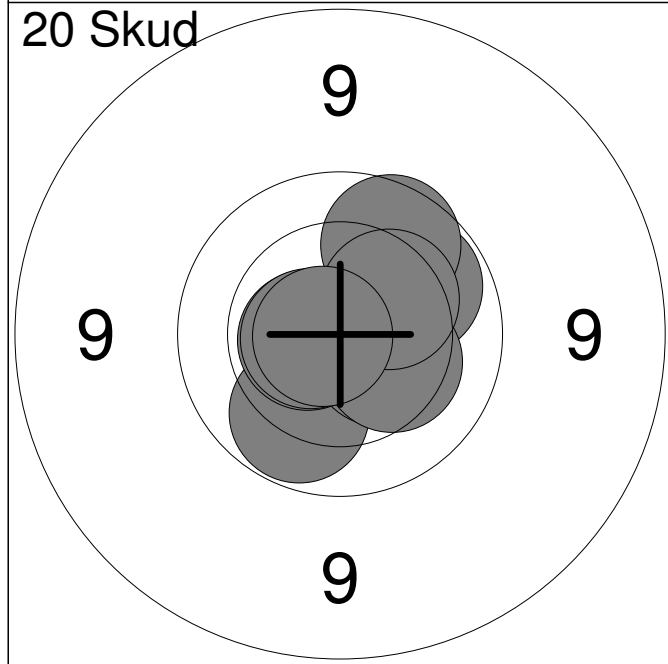

1:	10.8x	↓
2:	10.0	↘
3:	10.5	↘
4:	10.6x	←
5:	10.0	↗
6:	10.3	↘
7:	10.6x	←
8:	9.9	↗
9:	10.3	↗
10:	10.8x	←
<b>Serie</b>		<b>99.0</b>
<b>Total</b>		<b>99.0</b>

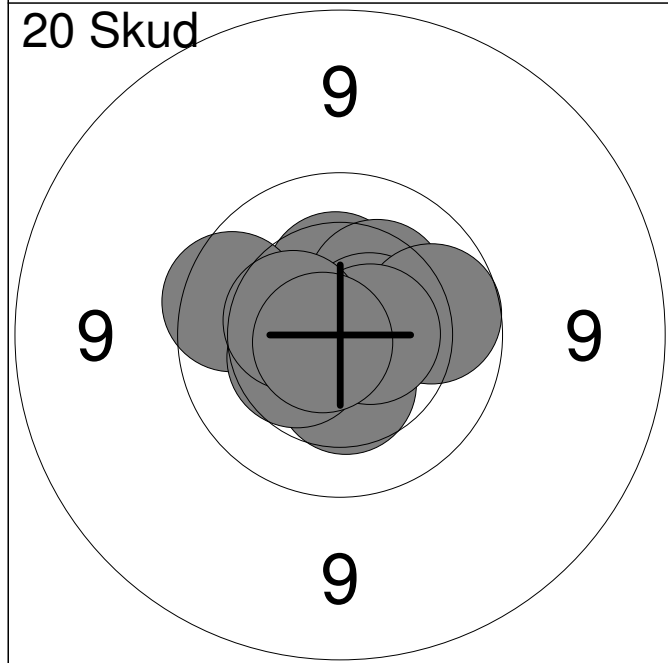

11:	10.4	↑
12:	10.4	↓
13:	9.8	←
14:	10.4	←
15:	10.3	↗
16:	10.6x	→
17:	9.9	→
18:	10.6x	→
19:	10.4	←
20:	10.7x	←
<b>Serie</b>		<b>98.0</b>
<b>Total</b>		<b>197.0</b>

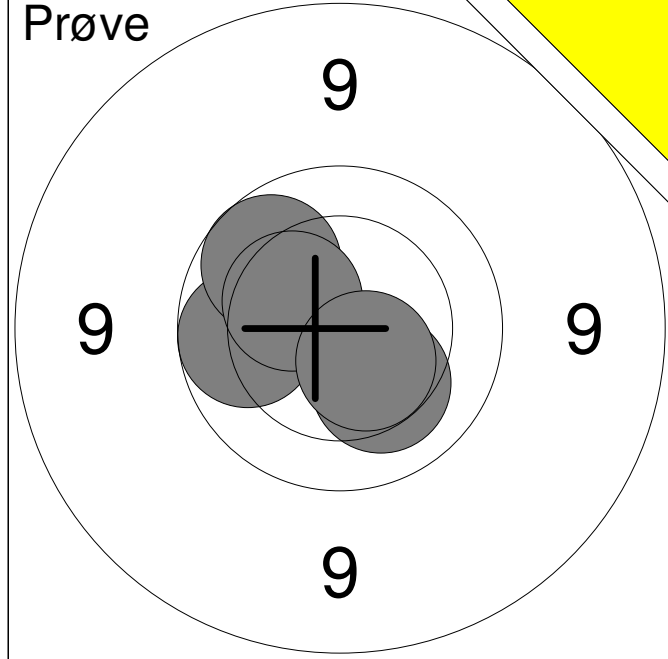

1:	9.9	←
2:	9.9	↗
3:	10.4	↗
4:	10.2	↘
5:	10.5x	↘
<b>Serie</b>		<b>48.0</b>
<b>Total</b>		<b>0.0</b>

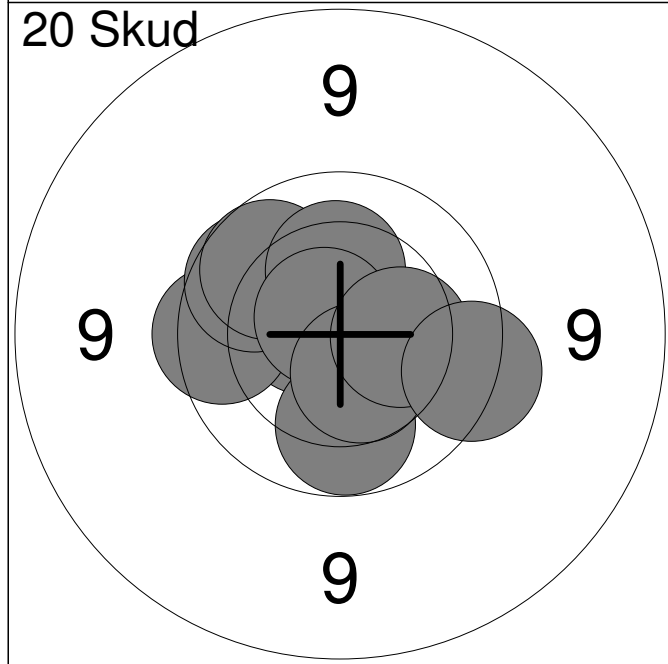

1:	10.6x	←
2:	9.8	←
3:	9.9	↗
4:	10.0	↘
5:	9.9	↗
6:	10.3	↑
7:	10.7x	↗
8:	10.5	↘
9:	10.3	→
10:	9.7	→
<b>Serie</b>		<b>96.0</b>
<b>Total</b>		<b>96.0</b>

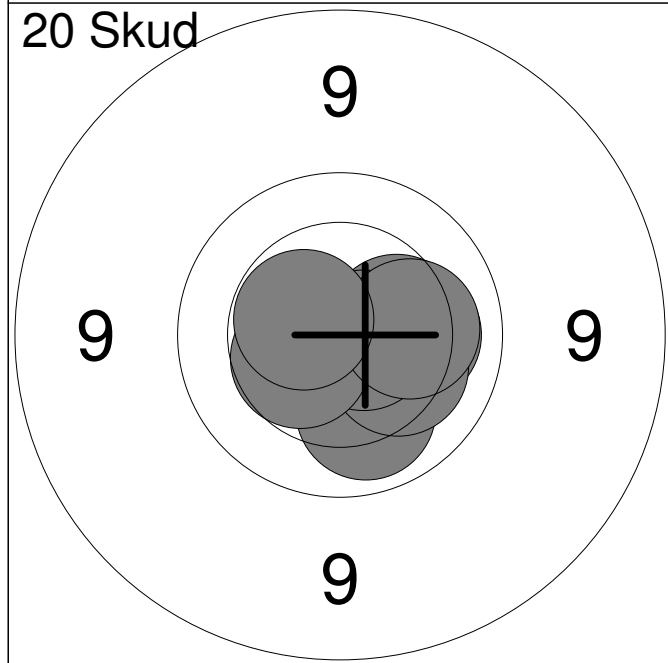

11:	10.2	↘
12:	10.7x	↘
13:	10.1	↘
14:	10.2	→
15:	10.3	→
16:	10.2	↘
17:	10.7x	→
18:	10.4	↖
19:	10.2	→
20:	10.5x	↖
<b>Serie</b>		<b>100.0</b>
<b>Total</b>		<b>196.0</b>

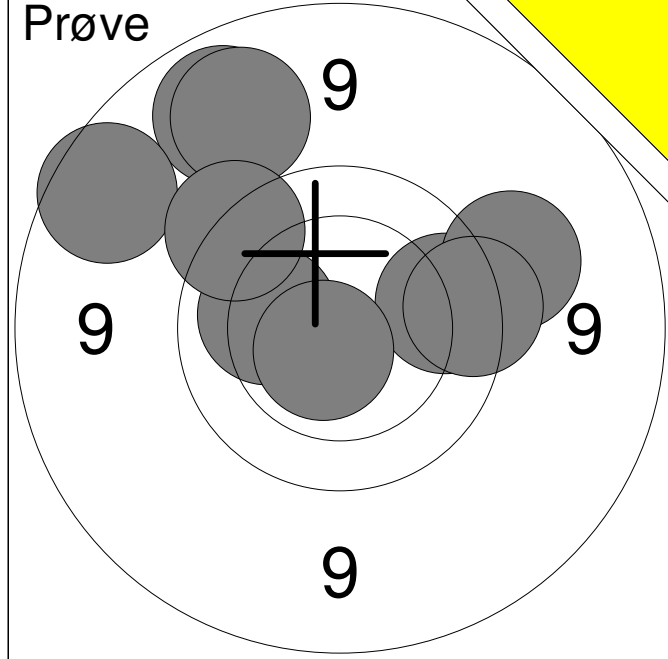

1:	9.9	→
2:	9.0	↗
3:	9.4	→
4:	10.2	←
5:	8.9	↗
6:	9.7	→
7:	9.1	↗
8:	10.7x	↘
9:	9.6	↗

Serie	82.0
Total	0.0

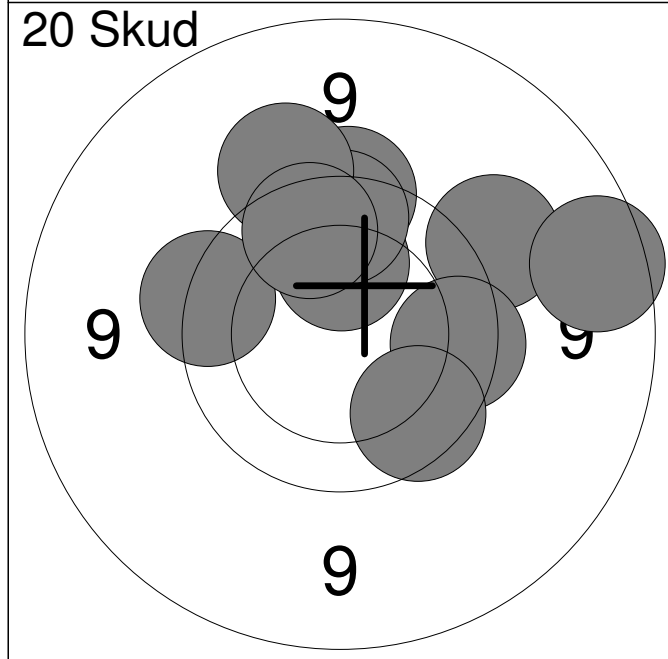

1:	9.4	↗
2:	9.6	↑
3:	9.8	→
4:	10.2	↑
5:	9.7	←
6:	9.8	↑
7:	9.4	↗
8:	8.9	→
9:	9.8	↘
10:	9.8	↗

Serie	90.0
Total	90.0

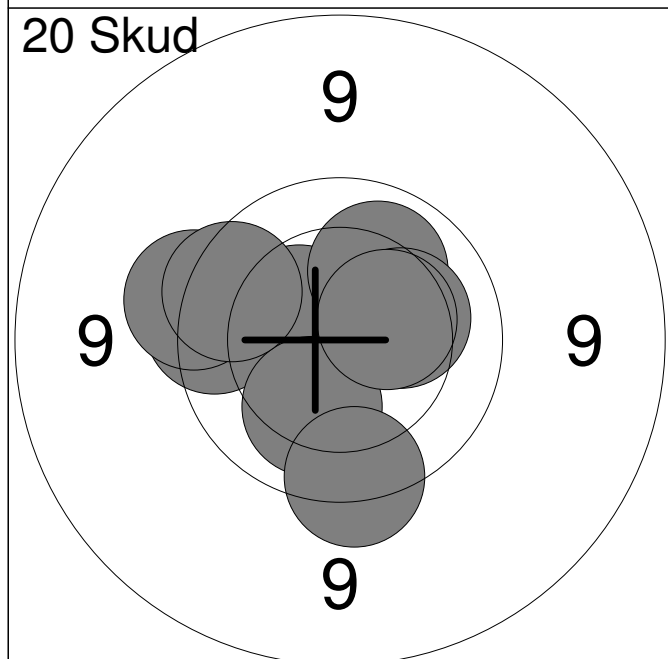

11:	10.7x	↗
12:	10.4	↗
13:	10.1	↗
14:	9.7	←
15:	10.2	↘
16:	10.3	→
17:	9.7	↓
18:	10.4	→
19:	9.6	←
20:	9.8	↖

Serie	96.0
Total	186.0

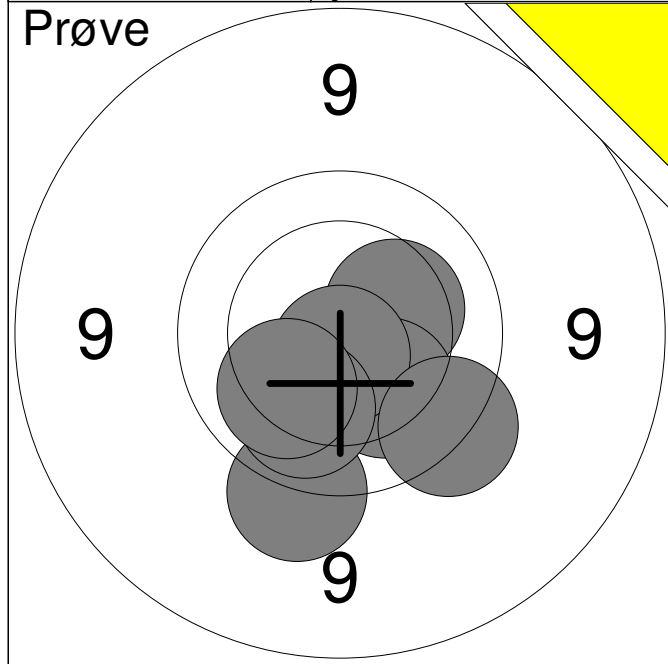

1:	10.3	→
2:	10.2	↓
3:	10.7x	↓
4:	9.6	↓
5:	9.5	↓
6:	10.1	↓
7:	10.1	↙
<b>Serie</b>		<b>68.0</b>
<b>Total</b>		<b>0.0</b>

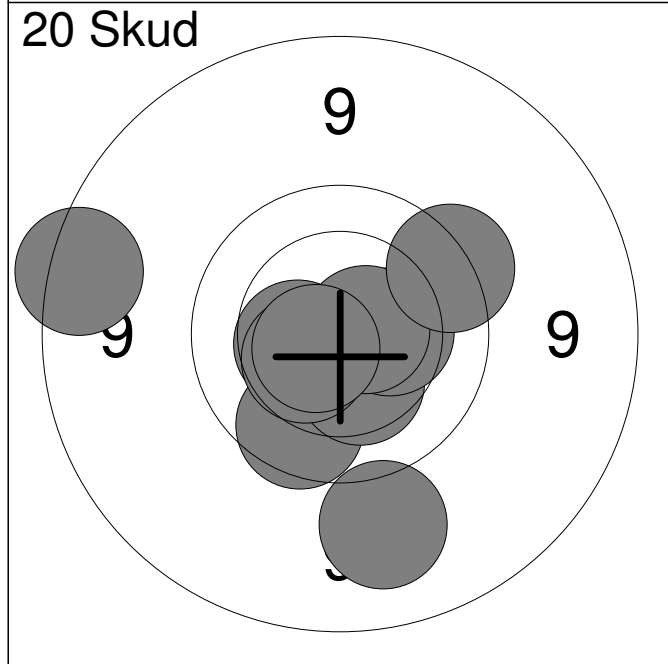

1:	9.9	↓
2:	9.2	↓
3:	10.4	←
4:	10.3	↓
5:	8.8	←
6:	10.4	→
7:	10.6x	→
8:	9.7	↗
9:	10.4	↙
10:	10.6x	↙
<b>Serie</b>		<b>95.0</b>
<b>Total</b>		<b>95.0</b>

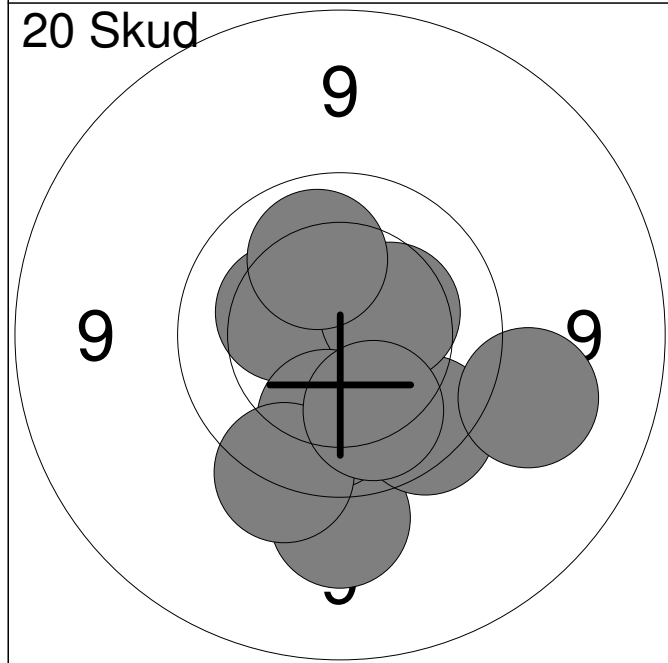

11:	10.5x	↓
12:	10.3	↗
13:	9.4	↓
14:	9.8	↓
15:	10.4	→
16:	10.0	↓
17:	10.1	↗
18:	9.6	↙
19:	9.3	↘
20:	10.1	↓
<b>Serie</b>		<b>96.0</b>
<b>Total</b>		<b>191.0</b>

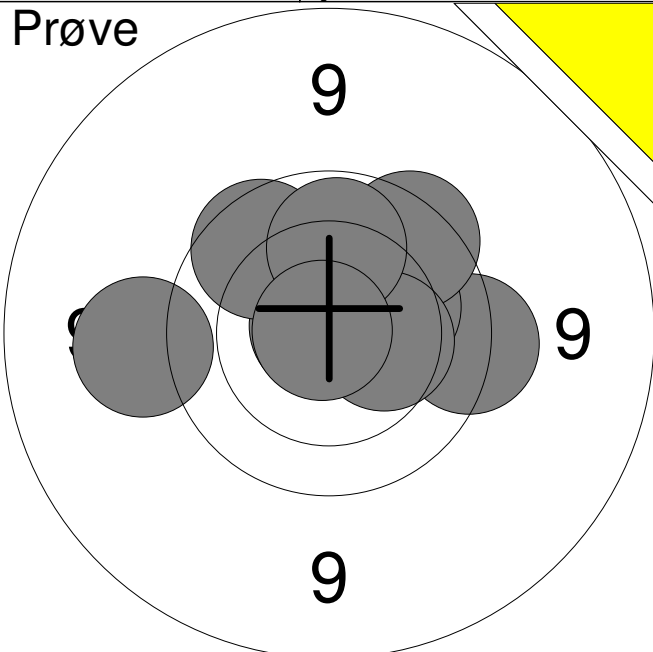
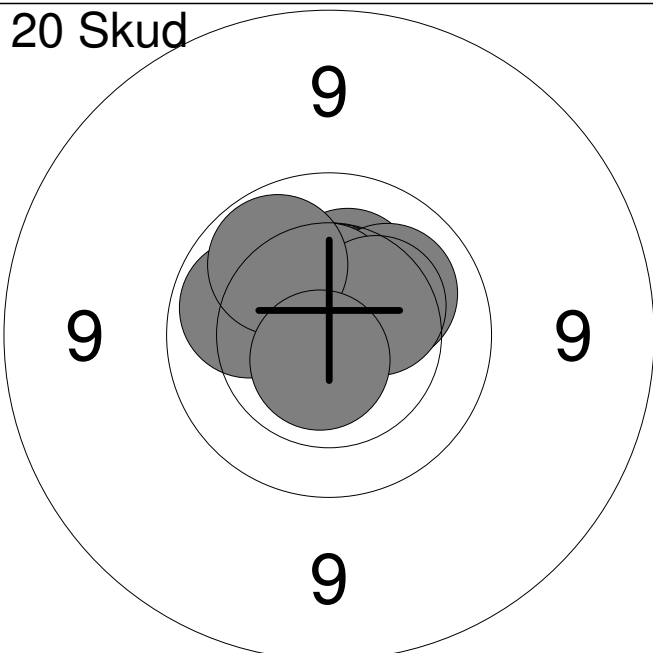
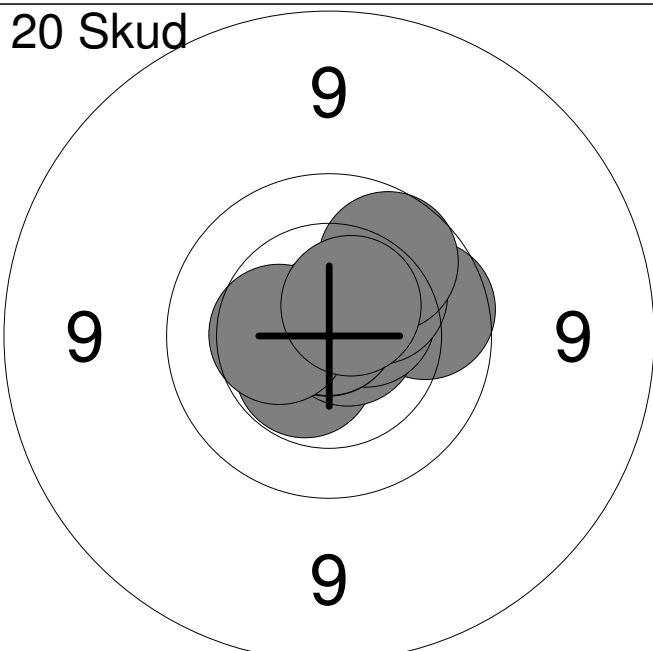

Hold	Skive	Daniel Mørk	
13	6	AAS	MUÅ1
		Hobro Egnens Skytteforening	
		Jyllandsstævne 2016	Aalborg Skyttekreds
<b>Prøve</b> 	1:	9.7	→
	2:	10.1	↗
	3:	10.2	→
	4:	9.8	↗
	5:	10.8x	↗
	6:	9.9	↗
	7:	10.4	→
	8:	10.0	↑
	9:	10.9x	↗
	10:	9.4	←
	Serie		96.0
Total		0.0	
<b>20 Skud</b> 	1:	10.3	↗
	2:	10.8x	↖
	3:	10.5x	↑
	4:	10.0	↖
	5:	10.5	↗
	6:	10.2	↗
	7:	10.5	↑
	8:	10.4	↗
	9:	10.0	↖
	10:	10.7x	↓
	Serie		100.0
Total		100.0	
<b>20 Skud</b> 	11:	10.5x	↙
	12:	9.9	→
	13:	10.7x	→
	14:	10.5x	↗
	15:	10.3	↗
	16:	9.9	↗
	17:	10.8x	↑
	18:	10.8x	↑
	19:	10.4	←
	20:	10.5x	↗
	Serie		98.0
Total		198.0	

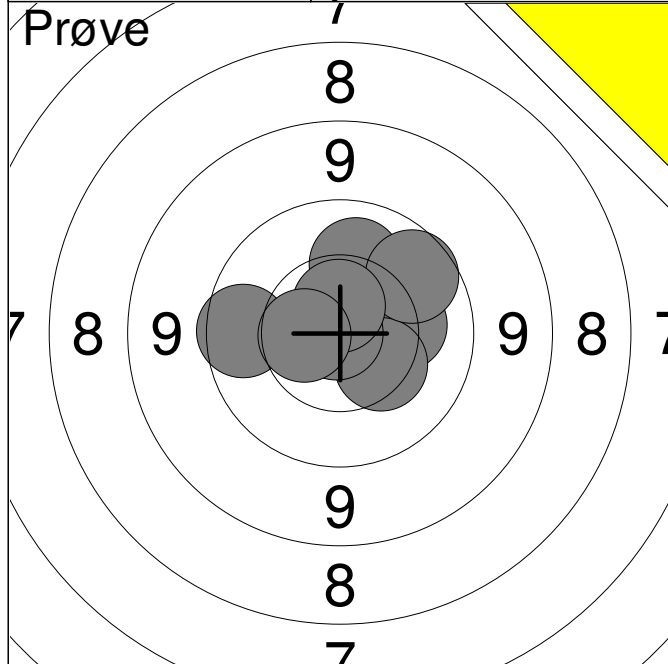

1:	10.1	↑
2:	10.2	→
3:	10.4	↘
4:	10.9x	←
5:	9.9	↗
6:	9.8	←
7:	10.6x	↑
8:	10.5	←

Serie	78.0
Total	0.0

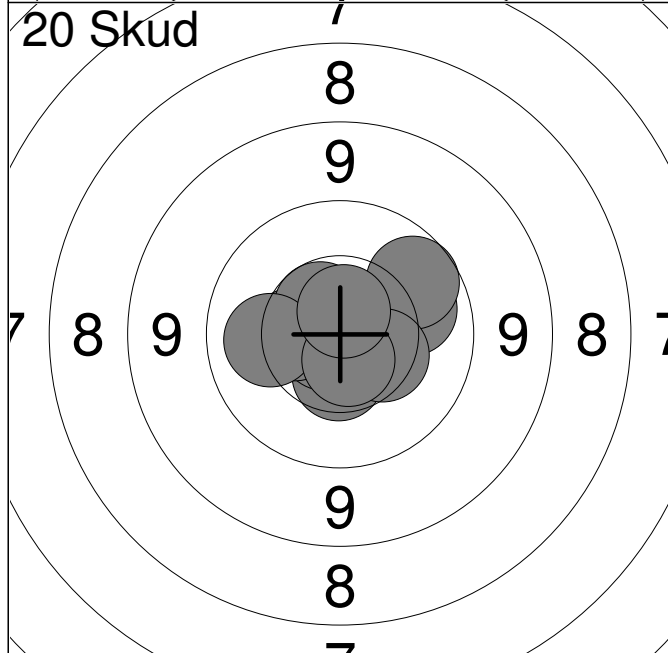

1:	10.5	↓
2:	10.7x	↙
3:	10.4	←
4:	10.6	↗
5:	10.1	←
6:	10.1	→
7:	9.9	↗
8:	10.4	↘
9:	10.6x	↓
10:	10.7x	↑

Serie	99.0
Total	99.0

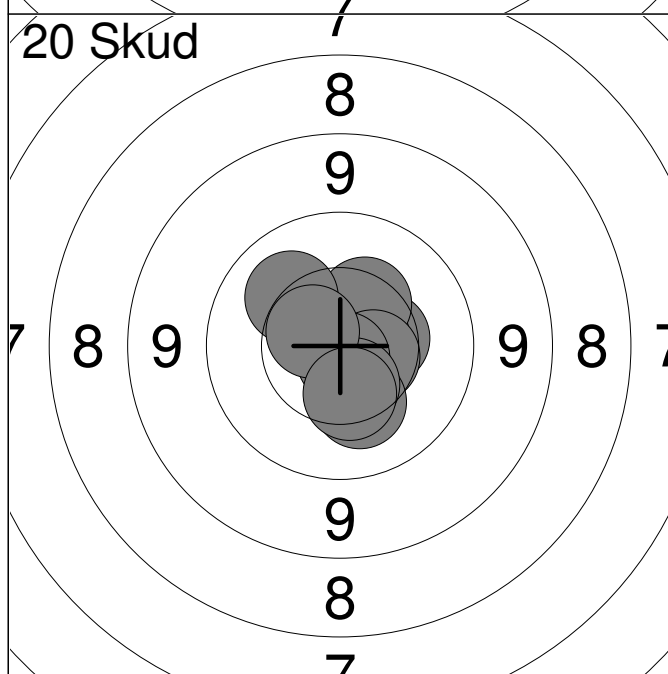

11:	10.4	→
12:	10.7x	→
13:	10.4	↗
14:	10.5	↘
15:	10.8x	↓
16:	10.2	↗
17:	10.3	↓
18:	10.5	↓
19:	10.6x	↗
20:	10.4	↓

Serie	100.0
Total	199.0

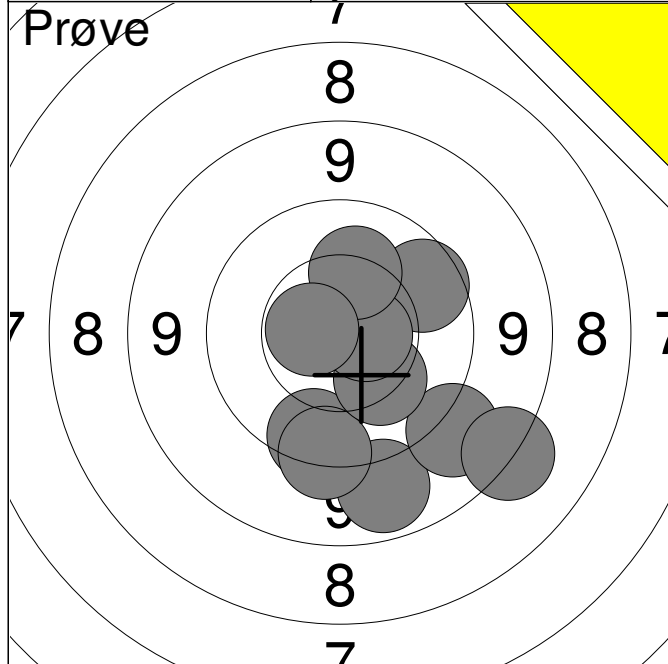

1:	9.7	↓
2:	9.0	↓
3:	9.2	↓
4:	9.5	↓
5:	8.4	↓
6:	10.3	↓
7:	9.8	↗
8:	10.6x	→
9:	10.2	↑
10:	10.6x	←
<b>Serie</b>		<b>93.0</b>
<b>Total</b>		<b>0.0</b>

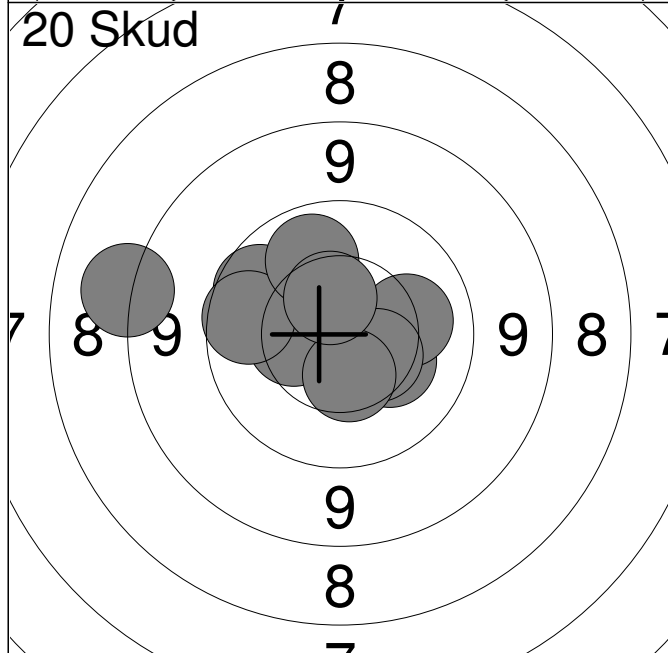

1:	10.3	↘
2:	10.2	→
3:	10.4	←
4:	10.5	↘
5:	9.9	↗
6:	8.3	←
7:	9.9	←
8:	10.0	↗
9:	10.5	↓
10:	10.5	↑
<b>Serie</b>		<b>96.0</b>
<b>Total</b>		<b>96.0</b>

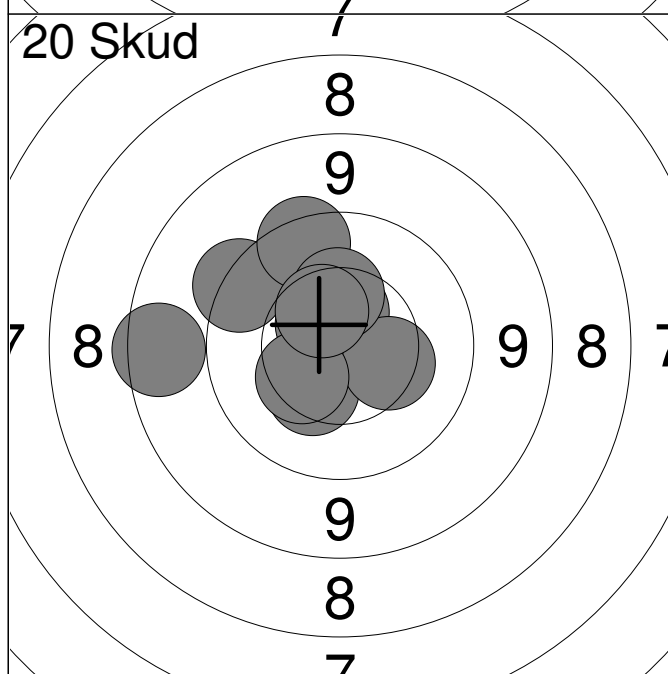

11:	9.6	↗
12:	10.6	↑
13:	10.6x	↗
14:	9.7	↗
15:	10.4	↓
16:	10.4	↘
17:	10.4	↙
18:	10.4	↑
19:	10.5	↗
20:	8.7	←
<b>Serie</b>		<b>96.0</b>
<b>Total</b>		<b>192.0</b>

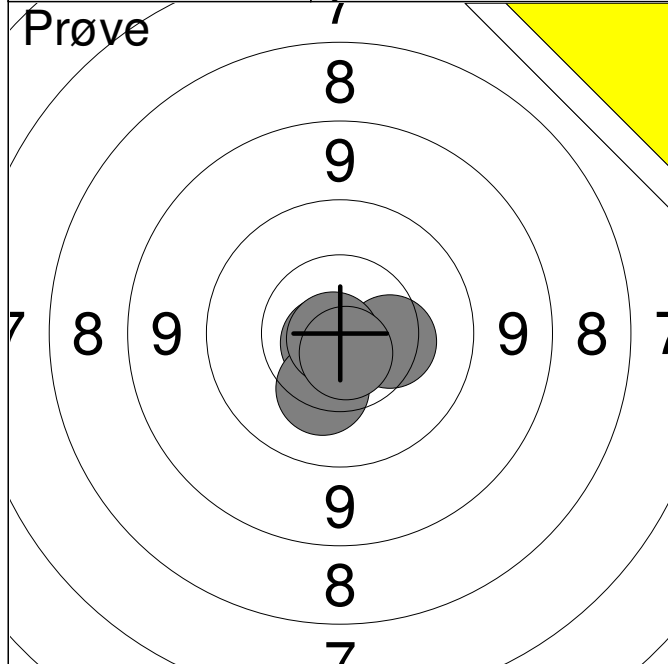

1:	10.4	→
2:	10.8x	↙
3:	10.3	↓
4:	10.9x	↙
5:	10.7x	↓
<b>Serie</b>		<b>50.0</b>
<b>Total</b>		<b>0.0</b>

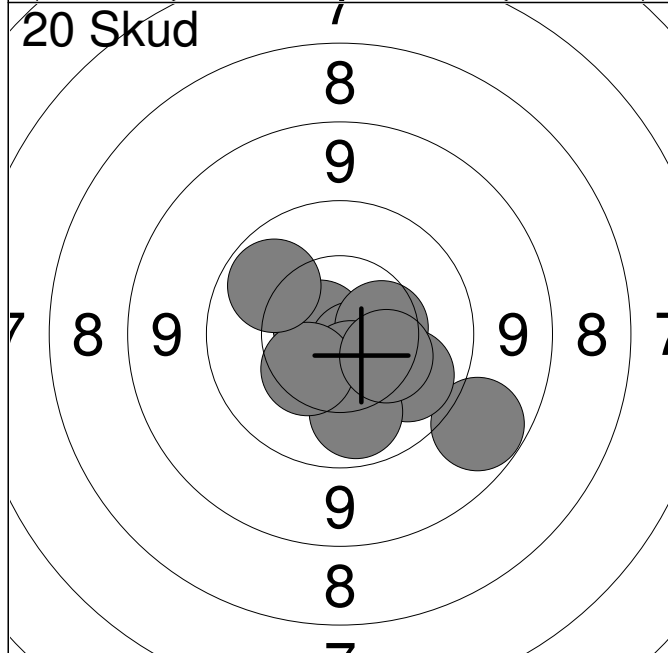

1:	10.7x	↖
2:	10.7x	↓
3:	9.0	↓
4:	10.5	→
5:	10.5	↓
6:	10.0	↘
7:	10.0	↓
8:	10.4	↙
9:	10.4	→
10:	10.0	↗
<b>Serie</b>		<b>99.0</b>
<b>Total</b>		<b>99.0</b>

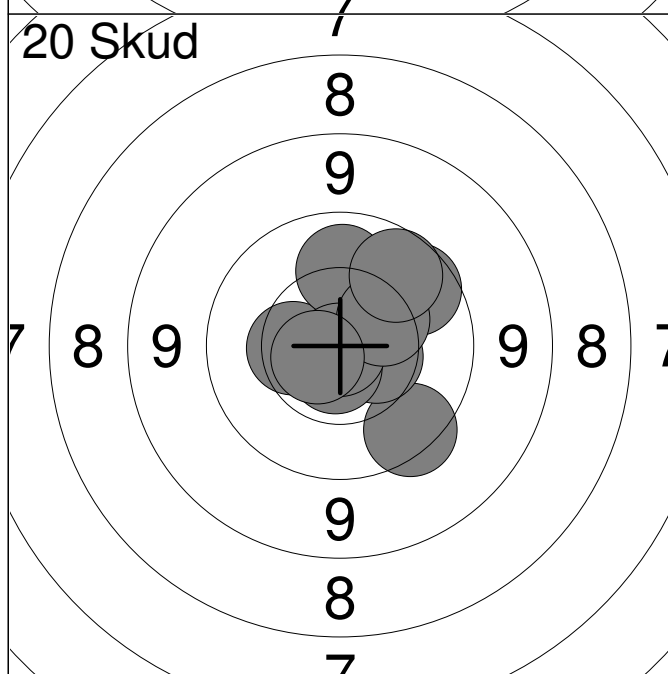

11:	10.4	←
12:	9.7	↓
13:	10.5	→
14:	9.8	↗
15:	10.1	↑
16:	10.7x	↓
17:	10.9x	↓
18:	10.4	↗
19:	10.7x	↙
20:	9.9	↗
<b>Serie</b>		<b>97.0</b>
<b>Total</b>		<b>196.0</b>

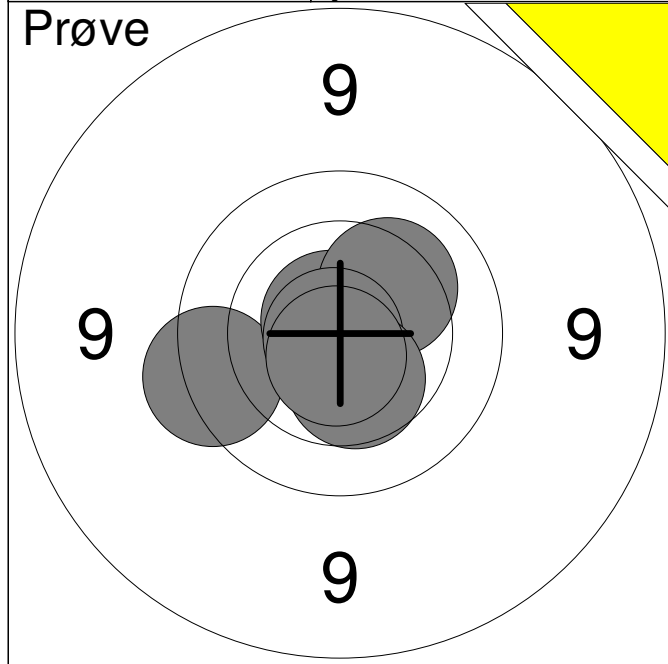

1:	9.7	←
2:	10.8x	↗
3:	10.2	↗
4:	10.9x	←
5:	10.4	↓
6:	10.7x	↓
<b>Serie</b>		<b>59.0</b>
<b>Total</b>		<b>0.0</b>

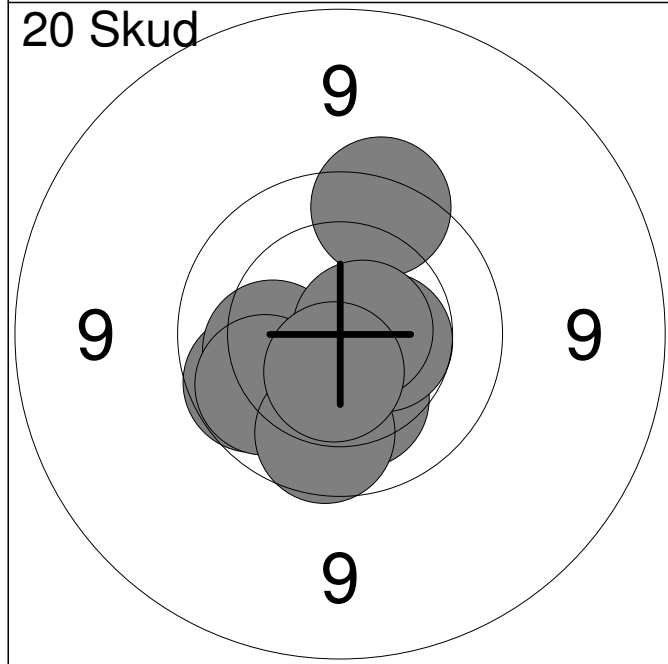

1:	10.2	↓
2:	10.0	←
3:	10.5	→
4:	9.7	↑
5:	9.9	←
6:	10.2	←
7:	10.0	←
8:	10.7x	→
9:	9.9	↓
10:	10.5x	↓
<b>Serie</b>		<b>97.0</b>
<b>Total</b>		<b>97.0</b>

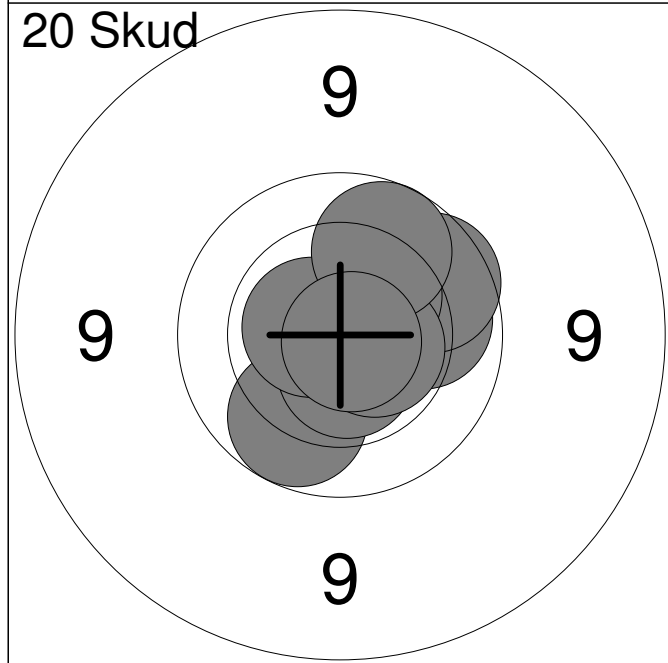

11:	10.0	→
12:	10.0	↓
13:	9.9	↗
14:	10.6x	↓
15:	10.8x	→
16:	10.4	↗
17:	10.6x	→
18:	10.6x	←
19:	9.9	↑
20:	10.8x	↘
<b>Serie</b>		<b>98.0</b>
<b>Total</b>		<b>195.0</b>

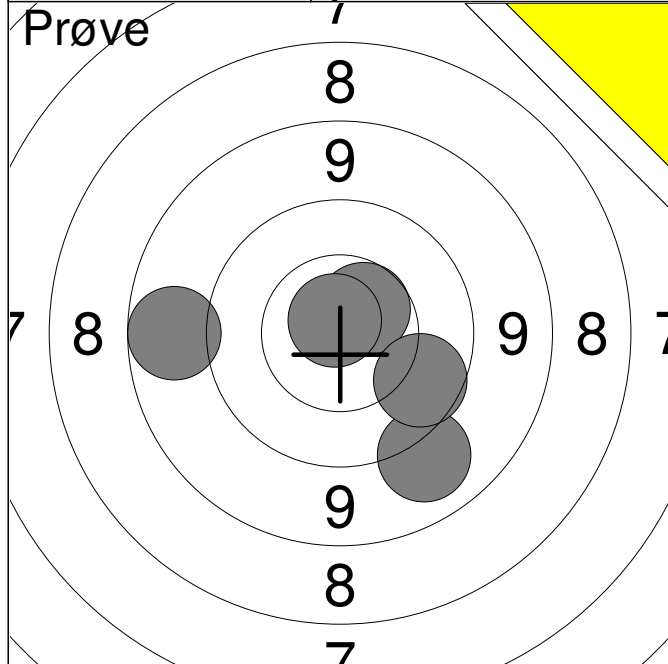

1:	9.2	↘
2:	8.9	←
3:	10.6	↗
4:	9.9	↘
5:	10.8x	↗

Serie	46.0
Total	0.0

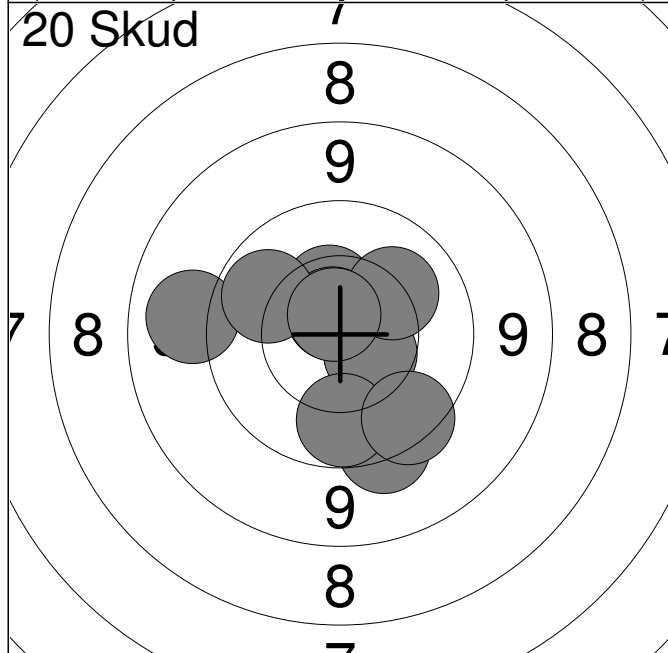

1:	10.4	↗
2:	9.5	↘
3:	10.5	↘
4:	10.7x	↗
5:	9.2	←
6:	10.2	↗
7:	10.0	↘
8:	9.7	↘
9:	10.0	↗
10:	10.7x	↗

Serie	97.0
Total	97.0

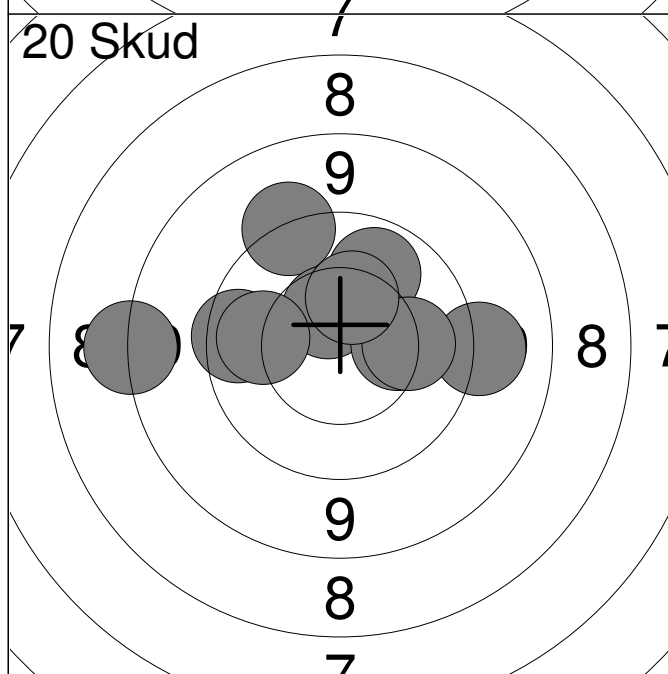

11:	9.3	→
12:	9.4	↗
13:	10.0	↗
14:	9.7	←
15:	10.5	↗
16:	8.4	←
17:	10.3	→
18:	10.1	←
19:	10.2	→
20:	10.4	↗

Serie	95.0
Total	192.0